

Date .....  
 User .....  
 End user weight (kg) .....  
 Language user manual .....

**Progeo (English)**  
 Company stamp

**Rigid frame wheelchair**

Responsible .....

**Wheelchair measures - The tolerance on all the dimensions indicated and/or required is ± 10 mm**

Seat width (LS)     33     36     39     42     45     48  
 The seat width is measured from the outer sides of the frame, while the distance between the two side guards is 1.5 cm wider.  
 For seat enlargement see section enlargement of mudguard

Seat depth (PS)     35     37,5     40     42,5     45     47,5     50  
 The real seat depth, from the front part of the seat cloth to the backrest tube will be 1,5 cm more than the declared one.

Footplate distance (DP) ..... (cm) ±0.5cm - adjustment steps 1.5cm  
 (Real distance between seat and footplate) - **IMPORTANT NOTICE! From the footplate to the floor minimum 4cm !! (Minimum Front height = DP + 4cm)**

Setting                    ☆ Standard                     Prudential                     Active                     Extreme

Backrest Height (TS)                    Std.Value 33,5 .....(min 26-max 47) adjustment steps 1.5cm

Camber                    ☆ 0°     2°     4°

**Frame's depth**

Front frame extension + 2,5 cm  
 Only available with black colour frame



12842

☆ Standard rear adjustment

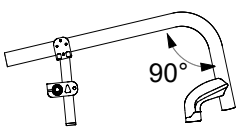

☆ Carbon fibre mudguard  
 Carbon fibre Straight sideguard

Removable version  
 The distance between the two side guards is 1 cm wider than the seat width

**Mudguard enlargement**  
 ☆ + 0 cm  
 + 1 cm

12648  
13597

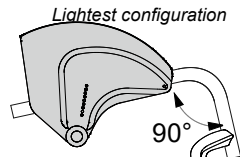

FULL CARBON rear adjustment plate with integrated sideguard  
*Lightest configuration*



☆ Version mudguard (Available only with rear wheels 24")

07646

**Front height - Tick the box with the required height**  
 The possible difference in height between HIGH frame and LOW frame is 3cm (with same fork, caster and assembly hole).

	 <i>SPORT fork (H95)</i>	 <i>Small size fork (H115)</i>
<b>LOW FRAME 90°</b> Front height (min 44,5 - max 50) Footplate distance (min 33) <div style="border: 1px solid black; padding: 5px; margin-top: 10px;"> <i>U-TUBE Aluminium footplate</i>              Footplate distance (min 18 + max 35)              DPmax = Front height - 10cm           </div>	Casters 3" <input type="checkbox"/> ~45 <input type="checkbox"/> ~46 4" <input type="checkbox"/> ~46 <input type="checkbox"/> ~47 5" <input type="checkbox"/> ~48,5	Casters 3" <input type="checkbox"/> ~45,5 <input type="checkbox"/> ~47 4" <input type="checkbox"/> ~46,5 <input type="checkbox"/> ~48 <input type="checkbox"/> ~49 5" <input type="checkbox"/> ~49 <input type="checkbox"/> ~50
<b>HIGH FRAME 90°</b> Front height (min 47,5 - max 53) Footplate distance (min 36) <div style="border: 1px solid black; padding: 5px; margin-top: 10px;"> <i>U-TUBE Aluminium footplate</i>              Footplate distance (min 21 + max 38)              DPmax = Front height - 10cm           </div>	Casters 3" <input type="checkbox"/> ~48 <input type="checkbox"/> ~49 4" <input type="checkbox"/> ~49 <input type="checkbox"/> ~50 5" <input type="checkbox"/> ~51,5	Casters 3" <input type="checkbox"/> ~48,5 <input type="checkbox"/> ~50 4" <input type="checkbox"/> ~49,5 <input type="checkbox"/> ~51 <input type="checkbox"/> ~52 5" <input type="checkbox"/> ~52 <input type="checkbox"/> ~53

**The real front-seat height could be slightly different from the chosen one considering it is affected by seat depth and rear seat height.**

**Rear height** .....                    **The difference between Front Height and Rear Height must be in the 3 - 12 cm range.**

Rear wheels 22" (min 36 - max 44)  
 Rear wheels 24" (min 38 - max 46)  
 Rear wheels 25" (min 39 - max 47)  
 Rear wheels 26" (min 41 - max 48)

Date ..... Order ..... User ..... Address .....

**Seat**  
 ☆ Seat cloth with pocket (under seat)  
 Seat with tension straps 08883  
 Carbon rigid seat 08336  
 Pocket (under seat) [25x11x4,5] 08281

**CUSTOMIZE COLORS**

**① Frame colour**  
 (without extra charge)  
 ☆ Opaque black  
 POLAR white  
 Matt orange  
 Tekno anthracite  
 Matt Midnight blue  
 Matt grey  
 Matt red

**Frame colour on request**  
 Bright silver  
 Bright red  
 Bright blue  
 Bright fuchsia  
 Bright lime

**② Fork colour**  
 ☆ Opaque black  
 Bright silver  
 POLAR white  
 Bright red  
 Tekno anthracite  
 Matt grey

**③ Colour rear wheels**  
 To be matched only with: Rear wheels Ultra-light Progeo - Standard! (22 - 24)  
 ☆ Black  
 Bright silver  
 POLAR white  
 Bright red  
 Tekno anthracite  
 Matt grey

12579  
08342  
04692

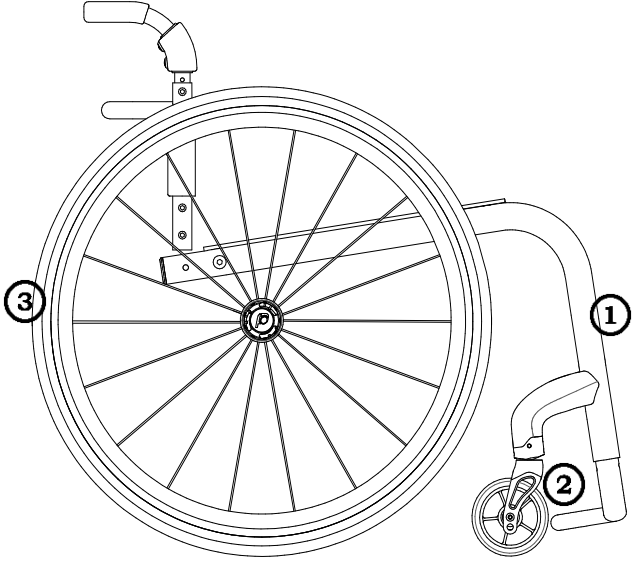

**Rear wheels axle**  
 ☆ Aluminum rear wheels axle  
 Carbon fiber rear wheels axle *Lightest configuration* 07647





**Backrest adjustment and fixing system**  
 ☆ Backrest with double locking (upright and folded) **with rake adjustable from -4° to +16°**  
 Backrest with upright locking system ONLY (no locking when folded) **with rake adjustable from -4° to +16°**  
 Fixed back(non-folding back) **with rake adjustable from -4° to +16°**

**Backrest**  
 ☆ Adjustable velcro straps and padded transpiring upholstery

Aluminium backrest  
 Titanium backrest 13599  
 Carbon fibre backrest 04389

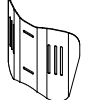

**AIR** **Integrated posture backrest (NOT REMOVABLE)**  
 Carbon shell - Lateral retaining 7,5cm  
 Depth adjustment ±1cm. - Angle adjustment ±10°  
 not available for seat width 48

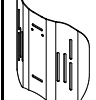
<b>H 28</b>		<b>H 34</b>		<b>H 40</b>	
Backrest Height (TS) min 34		Backrest Height (TS) min 38		Backrest Height (TS) min 44	
( ..... )		( ..... )		( ..... )	
Lateral retaining wing A=high - R=regular					
<b>A</b>	<b>R</b>	<b>A</b>	<b>R</b>	<b>A</b>	<b>R</b>
					
<input type="checkbox"/>	<input type="checkbox"/>	<input type="checkbox"/>	<input type="checkbox"/>	<input type="checkbox"/>	<input type="checkbox"/>

**Installation on:**  
 ☆ Backrest tubes

Aluminium backrest  
 Titanium backrest 13599  
 Carbon fibre backrest 04389

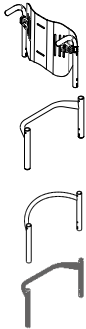

Date .....	Order .....	User .....	Address .....
------------	-------------	------------	---------------

**Handle tube**

☆ Tubes with standard handle

Tubes with short handle

SPORT tubes Without push handles

Carbon fibre tubes with short handle *Lightest configuration* 04390

**Not available with: Posture backrest PHYSIO - Posture backrest A I R**

Folding handles **Minimum backrest height 30,5cm** 13598

Not available with: Push handles for companion



**Casters**

☆ 4" Soft

3" Sport *Lightest configuration*

5" Soft

3" Active Soft (wide) (Aluminium alloy rim) 13592

4" Active Sport (narrow) (Aluminium alloy rim) 13593

4" Active Soft (wide) (Aluminium alloy rim) 13594

5" Active Soft (wide) (Aluminium alloy rim) 13595

5" Pneumatic 13596

**Rear wheels**

☆ 24" Ultra-light Progeo - Standard!

22" Ultra-light Progeo - Standard!

25" Ultra-light Progeo - Standard! (colour: black)

26" Progeo - Standard! (colour: black)

24" ULTRA-LIGHT PROGEO KEY SPORT *Lightest configuration* 13585

24" Ultra-light "Spinergy LX" 13586

24" Ultra-light "Spinergy LXL"  Black hub and white spokes  Hub and spokes black 13587

24" Ultra-light "Spinergy Flex rim" Integrated aluminium/rubber handrim 02270

25" Ultra-light "Spinergy LX" 13588

25" Ultra-light "Spinergy LXL"  Black hub and white spokes 13589

26" Ultra-light "Spinergy LX" 13590

24" Off-road (aluminium handrim black - Wheel distance 4cm) 01392

**Rear wheel tyre**

☆ High pressure tyre (22"-24"-25"-26") *Lightest configuration*

High pressure profile tyre (24")

Marathon Plus (24"-25") with anti-puncture protection 01669

Anti-puncture - Colour Grey (22") 04181

Anti-puncture - Colour Black (24") 11083

**Not available with Rear wheels : 24" ULTRA-LIGHT PROGEO KEY SPORT, 24" Ultra-light "Spinergy LXL"**

**Handrim** **Wheel distance ☆ 3 cm**  **4 cm**

☆ Aluminium (22"-24"-25"-26") *Lightest configuration*

Aluminium black SOFT-TOUCH (24"-25") (24" handrim, on 25" wheel is installed with spacers) 09170

Chromed Steel (24"-25") (24" handrim, on 25" wheel is installed with spacers) 01684

Titanium (24"-25") (24" handrim, on 25" wheel is installed with spacers) 13591

Ultra Grepp (24"-25") (24" handrim, on 25" wheel is installed with spacers) 00017

TOP FRICTION (24"-25") (24" handrim, on 25" wheel is installed with spacers) 11023

Oval countour with a rubber insert

NOVA H (24"-25") (24" handrim, on 25" wheel is installed with spacers) 11025

Ergonomic black profile

NOVA D (24"-25") (24" handrim, on 25" wheel is installed with spacers) 11026

Ergonomic profile with rubber coating (ideal for quadriplegics)

Silicon cover for standard aluminium handrim Available for measures (22"- 24" - 26") 04050

**Wheel locks**

☆ Bent lever push to lock

Straight lever push to lock

Straight lever pull to lock

Sport brake 06428

Brake with extension lever push to lock 01949

Brake with extension lever pull to lock 03372

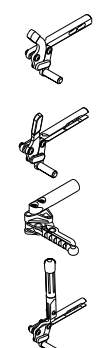

Date .....	Order .....	User .....	Address .....
------------	-------------	------------	---------------

**Footplate**

☆ Aluminium footplate. Rake not adjustable

☆ Aluminium footplate  with plastic plate

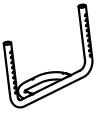
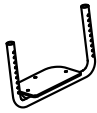
One piece aluminium footplate - Flip-up! FLIP-BACK! - rake and depth adjustable  
**IMPORTANT NOTICE!** From the footplate to the floor minimum 6cm !! (Minimum Front height = DP + 4cm)  
 With 5" front wheel the difference between Front Height and Rear Height must be greater than 5cm





Aluminium footplate - rake and depth adjustable

☆ Internal     2/3 Internal     External     2/3 External

U-TUBE - Aluminium footplate, rake and depth adjustable  
**LOW FRAME: minimum footplate distance 18 - maximum footplate distance 35**  
**HIGH FRAME: minimum footplate distance 21 - maximum footplate distance 38**

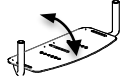
One piece Carbon fibre footplate. Rake adjustable

☆ Internal     External

09420  
04456  
09853  
04110

**Armrests**

Tubular armrests (Swing away, removable and height adjustable armrest)



Removable armrest with carbon-fiber straight sideguard  
**Available only with: Standard rear adjustment**



00694  
09079

**Accessories**

Pad for front frame protectors 07058

Backrest-seat connection cloth 10241

Removable storage bag (with quick coupling) 09811

**Optional 1**

Only one optional devices for side can be chosen

Transit wheels Exclude the installation of Anti-tippers 03290



Anti-tipper with rapid hookup Exclude the installation of Transit wheels (inside rotation to reduce the encumbrance)

Right 06821

Left 06822



**Optional 2**

Push handles for companion (Removable and height adjustable) 13600



Tetracclip (Quick release axle for quadriplegic) 03947

Safety pelvic belt 03972

Harness 04103

Lumbar support (to insert in the backrest upholstery) 00013

Right swing away lateral support Not available with Posture backrest PHYSIO - Posture backrest A I R

Prevents backrest folding

Right 02097

Left 02098



Spoke guards Black (22"-24") 01043

Spoke guards Transparent (22"-24") 00835

Spoke guards Progeo design (22"-24") 00019

**Additional Kit**

24" Off-road rear wheels Off-Road tyre - aluminium handrim (black colour) 03378







24" FAT rear wheels FAT tyre 3" - aluminium handrim (black colour) 09357

Date ..... Order ..... User ..... Address .....





**PHYSIO - Posture backrest**  
(Std. Backrest upholstery not provided)

Removable with quick release  
Suitable for tubes with diameter 18+26mm  
Depth adjustment (4cm)  
Angle adjustment ( $\pm 18^\circ$ )

- AIR** Carbon shell  
not available for seat width 48

BACKREST HEIGHT	28	34	40			
Shell's shape  7.5 cm	Lateral retaining wing A=high - R=regular					
	A	R	A	R	A	R
						
	<input type="checkbox"/>	<input type="checkbox"/>	<input type="checkbox"/>	<input type="checkbox"/>	<input type="checkbox"/>	<input type="checkbox"/>

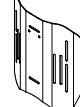
- POSTURE** Aluminum shell

BACKREST HEIGHT	34	40	52
Shell's shape  7.5 cm	Lateral retaining wing R=regular		
	R	R	R
			
	<input type="checkbox"/>	<input type="checkbox"/>	<input type="checkbox"/>

**Configuration DEEP with side support PAD (height adjustable)**

Alluminum lateral with padded, breathable upholstery.



Small (h 13cm)



Right  
10272

Left  
10272

Large (h 20cm)



Right  
10273

Left  
10273

**SWING AWAY - Lateral support**

Fixing and adjustment hardware complete with protection sleeve  
Alluminum lateral with padded, breathable upholstery.

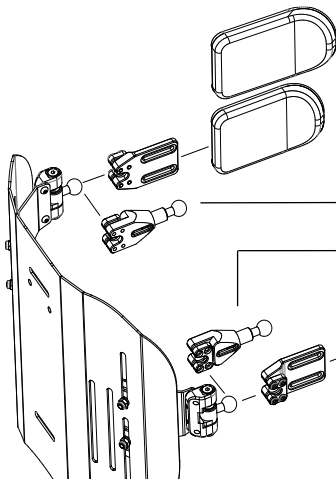

Large (18x12)

05647

Small (14x9)

05643

Lateral support extension

Quantity (number pcs).....  
10271

Lateral support extension

Quantity (number pcs).....

Small (14x9)

05642

Large (18x12)

05646

- Headrest adjustable - Double ball mounting system

Available only with backrest Physio Posture



Large (35x12,5)  
 Small (25x12,5)

05648

Date .....	Order .....	User .....	Address .....
------------	-------------	------------	---------------

**Note**

<p>Wheelchair : Progeo JOKER R2 - Rev. 2026.0</p>	<p>Prices - VAT excluded to be added to the price list</p>	<p style="text-align: center; font-size: small;">Send this page only if any optional have been chosen</p> <table style="width: 100%; border-collapse: collapse;"> <tr> <td style="width: 15px; text-align: center;"><input type="checkbox"/> ☆</td> <td style="padding: 2px;">standard</td> <td style="font-size: x-small; padding-left: 5px;">(supplied if no requests are indicated)</td> </tr> <tr> <td style="text-align: center;"><input type="checkbox"/></td> <td style="padding: 2px;">on request</td> <td style="font-size: x-small; padding-left: 5px;">(without extra charge)</td> </tr> <tr> <td style="text-align: center;"><input type="checkbox"/></td> <td style="padding: 2px;">optional</td> <td style="font-size: x-small; padding-left: 5px;">(cost to be added at the basic price)</td> </tr> </table>	<input type="checkbox"/> ☆	standard	(supplied if no requests are indicated)	<input type="checkbox"/>	on request	(without extra charge)	<input type="checkbox"/>	optional	(cost to be added at the basic price)
<input type="checkbox"/> ☆	standard	(supplied if no requests are indicated)									
<input type="checkbox"/>	on request	(without extra charge)									
<input type="checkbox"/>	optional	(cost to be added at the basic price)									

Date .....	Order .....	User .....	Address .....
------------	-------------	------------	---------------

12" wheel - Motor 250W (750W maximum power)  
 14" wheel - Motor 1000W (1500W maximum power)

- Color display with switcher
- Maximum speed limit settable from display
- 5 speed levels selectable
- 10 display-selectable acceleration levels
- Adaptive Cruise Control
- Disc and electronic brake control lever
- Motor brake (adjustable in 10 levels from the display)
- Electronic brake with control bottom (adjustable in 10 levels from the display)
- Power regain when braking
- Error messages management from display (with error history)
- Rear gear beeper
- 48V - 5.8 Ah battery Autonomy up to 25km
- 48V - 11.6 Ah Power plus battery Autonomy up to 50km
- Battery charger 48V
- Rear gear
- USB port
- Easle
- Mudguard
- Front spoiler with predisposition for FULL LED light

**(Certified software)**

**Mototronik**

**10979**



**Handlebar**

☆ **STANDARD controls**

☆ Thumb accelerator

☆ Right  
12592

Left  
12593

Grip throttle

Right  
10913

Left  
10914

Disc and electronic brake control lever

☆ Right  
12594

Left  
12595

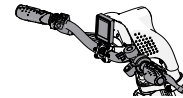

**QUADRIPLEGIC controls**  
 Handlebar PUSH&PULL

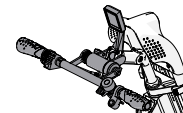

**10905**

☆ **MOTOTRONIK 12" wheel**

Motor 250W (750W maximum power)  
 Maximum speed according to law

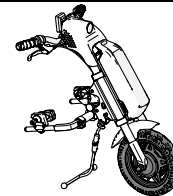

**MOTOTRONIK 14" wheel**

Motor 1000W (1500W maximum power)  
 Maximum speed according to law

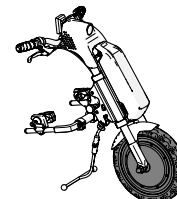

**10903**

**Battery**

☆ 48V - 5.8 Ah battery

*Autonomy up to 25 km*





48V - 11.6 Ah Power plus battery

*Autonomy up to 50 km*

**10904**

Date ..... Order ..... User ..... Address .....

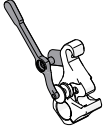
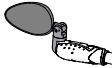
### Accessories

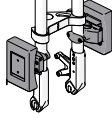
- FULL LED light (high intensity)  
 Integrated in the spoiler  10908
  
- Handlebar extension  
 Adjustable from 15cm up to 23cm  10907
  
- Motor unit facilitated unlock lever  
 Recommended with handlebar for quadriplegic  10915
  
- Additional FLY 48V - 2.9 Ah battery  
 Autonomy up to 15km  
 Approved for air transport 10906
  
- Rearview mirror  Right  
 Left  10909  
 10909
  
- Basket (removable) - (with KLICKfix® attachment system)  10912
  
- Removable front weight - (with KLICKfix® attachment system)  
 (it increases the weight over the power wheel to improve traction)  10910
  
- Travel bag 10916

### Note

Send this page only if any optional have been chosen

Wheelchair : Progeo JOKER R2 - Rev. 2026.0

Prices - VAT excluded  
to be added to the price list

- standard (supplied if no requests are indicated)
- on request (without extra charge)
- optional (cost to be added at the basic price)



Date .....	Order .....	User .....	Address .....
------------	-------------	------------	---------------

**SMARTDRIVE - including battery charger**



	<p><b>SWITCH CONTROL (DX+SX) - EU</b> Funzionamento a due pulsanti</p>	<input type="radio"/> 6 KM/H	MX2-S002
		<input type="radio"/> 9 KM/H	MX2-S005

	<p><b>SWITCH CONTROL + JACK 3.5 - EU</b> "Mono" female input, allows SmartDrive to be connected to any other control/driving device.</p>	<input type="radio"/> 6 KM/H	MX2-S003
		<input type="radio"/> 9 KM/H	MX2-S006

**Pulsante di comando esterno BUDDY BUTTON**  
completo di adattatore, set di montaggio e braccio di estensione  
*Disponibile solo con SWITCH CONTROL + JACK 3.5*



MX2-BBB

**ATTACHMENT HARDWARE FIX FRAME KIT**  
Choose attachment hardware kit according to the size of the wheelchair's rear wheels

<input type="checkbox"/> Attachment hardware fix frame kit - rear wheels 22" - 24"	MX2-44S-C
<input type="checkbox"/> Attachment hardware fix frame kit - rear wheels 25"	MX2-45S-C
<input type="checkbox"/> Attachment hardware fix frame kit - rear wheels 26"	MX2-46S-C

**SMART WATCH**

Lo SmartDrive può essere comandato e gestito con uno Smart Watch APPLE o GALAXY  
 Fast and simple setup  
 Increased screen visibility  
 Improved battery performance  
 Free App from Apple Store and Play Store

**Lista compatibilita'**



**Smart Watch compatibili**

**APPLE WATCH**  
serie 5 o successivi con iOS 8 o successivi  
Apple iPhone

**GALAXY WATCH**  
serie 4 o successivi  
Smartphone Samsung  
Smartphone Android 6.0 e RAM almeno 1.5 GB

**Applicazioni gratuite**

SmartDrive MX2+



Pushtracker



**Accessories**

<input type="radio"/> Carrying bag	 <p>MX2SD-BAG</p>
<input type="radio"/> Universal padded handle <i>Universal padded handle</i>	 <p>MX2-986</p>

Wheelchair : Progeo JOKER R2 - Rev. 2026.0	Prices - VAT excluded to be added to the price list	<p style="text-align: center; font-size: small;">Send this page only if any optional have been chosen</p> <table style="width: 100%; border-collapse: collapse;"> <tr> <td style="width: 10%; text-align: center;">★</td> <td style="width: 60%;">standard</td> <td style="width: 30%; text-align: right; font-size: x-small;">(supplied if no requests are indicated)</td> </tr> <tr> <td style="text-align: center;">□</td> <td>on request</td> <td style="text-align: right; font-size: x-small;">(without extra charge)</td> </tr> <tr> <td style="text-align: center;">○</td> <td>optional</td> <td style="text-align: right; font-size: x-small;">(cost to be added at the basic price)</td> </tr> </table>	★	standard	(supplied if no requests are indicated)	□	on request	(without extra charge)	○	optional	(cost to be added at the basic price)
★	standard	(supplied if no requests are indicated)									
□	on request	(without extra charge)									
○	optional	(cost to be added at the basic price)									