

Date .....

User name .....

Company stamp

Responsible .....

**Carbon fibre frame made-to-measure.**

**Keep attention to all measures.**  
NOIR is a wheelchair without possibilities of adjustments after its manufacturing.  
See reference tables  
Take care to write all the requested measures (in centimetres)

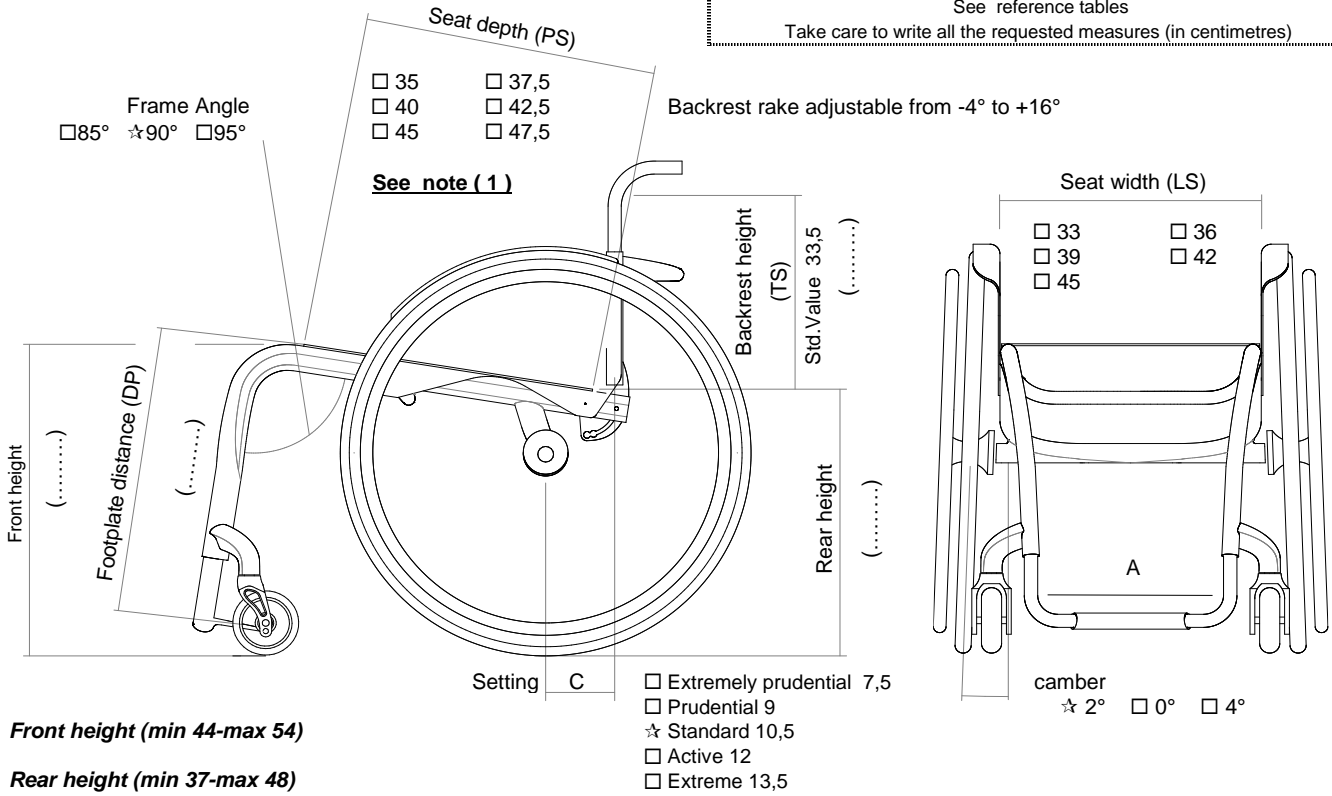

**ESSENCE**

- CARBON Essence  
Polished transparent painting
- OPAQUE Essence 08925 £ 545  
Opaque transparent painting
- LIME Essence 08926 £ 764
- RED Essence 08927 £ 764
- BLUE Essence 08928 £ 764
- ANTHRACITE + OPAQUE Essence 08929 £ 982
- GOLD Essence 10071 £ 1309
- SILVER Essence 10072 £ 1309

**Fork colour**

- Opaque black
- Pearl white

**Footplate option**

Carbon fibre frame with integrated footplate, not adjustable  
(Lightest configuration)

Aluminium footplate adjustable distance +/- 1,5cm (rake and depth adjustable)  
Minimum footplate distance 35cm.

- Internal  2/3 Internal
- External  2/3 External

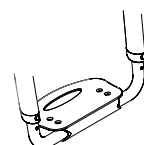

Date ..... Order ..... English User name ..... Address .....

**Seat**

- ☆ Seat cloth with pocket (under seat)
- Seat with tension straps 08883 **£ 196**
- Carbon rigid seat 08336 **£ 415**
  - Pocket (under seat) [25x11x4,5] 08281 **£ 65**

**Backrest with rake adjustable from -4° to +16°**

- ☆ Backrest with double locking (upright and folded)
- Backrest with upright locking system ONLY (no locking when folded)
- Fixed back(non-folding back)
- ☆ Carbon fibre backrest (Lightest configuration)
- Titanium backrest

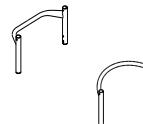

- AIR - Integrated posture backrest (not removable) - Lateral retaining 6,5cm.** 06815 **£ 1015**  
not available for seat width 48 - Std. Backrest upholstery not provided - Handle tube aluminium with short tubes

**Lateral retaining wing B=low**

**Carbon shell H25**

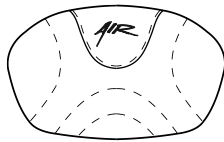

Backrest Height (TS) min 29 ..... max 41

**Carbon shell H33**

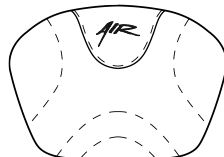

Backrest Height (TS) ..... (37 + 46)

**Lateral retaining wing A=high**

**Carbon shell H30**

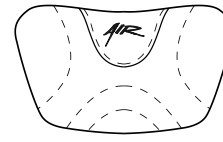

Backrest Height (TS) ..... (32 + 42,5)

**AIR Cover**

- ☆ Cover Standard - fabric insert: GREY, stitchings GREY

- Cover SPORT** 09195 **£ 87**

- fabric insert: BLACK - Stitchings GREY
- fabric insert: BLACK - Stitchings LIME
- fabric insert: BLACK - Stitchings ORANGE
- fabric insert: BLACK - Stitchings RED
- fabric insert: BLACK - Stitchings BLUE
- fabric insert: BLACK - Stitchings BLACK
- fabric insert: BLACK - Stitchings FUCHSIA
- fabric insert: BLACK - Stitchings ANTHRACITE

- Cover ACTIVE** 09195 **£ 87**

- fabric insert: RED - Stitchings BLACK
- fabric insert: LIME - Stitchings BLACK
- fabric insert: BLUE - Stitchings BLACK

fabric insert:

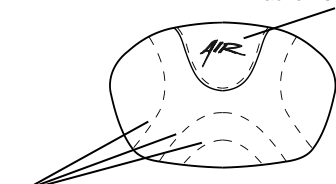

Transpiring fabric stitchings

**Handle tube**

- ☆ Handle tube with short tubes
- Handle tube SPORT Without push handles (Lightest configuration)
- Folding handles aluminium



02958 **£ 218**

**Casters**

- ☆ 3" Sport (Lightest configuration)
- 4" Soft
- 3" Active Soft (wide) (Aluminium alloy rim)
- 4" Active Sport (narrow) (Aluminium alloy rim)
- 4" Active Soft (wide) (Aluminium alloy rim)
- 5" Active Soft (wide) (Aluminium alloy rim)

**Rear wheels - See chart N°3**





- ☆ 24" ULTRA-LIGHT PROGEO KEY SPORT (Lightest configuration)
- 24" Ultra-light "Spinergy LX"
- 24" Ultra-light "Spinergy LXL"  Black hub and white blade spokes  Hub and blade spokes black
- 25" Ultra-light "Spinergy LX"
- 25" Ultra-light "Spinergy LXL"  Black hub and white blade spokes
- 26" Ultra-light "Spinergy LX"

English

<u>Date</u>	<u>Order</u>	<u>User name</u>	<u>Address</u>
-------------	--------------	------------------	----------------

<b>Rear wheel tyre</b>				
<input checked="" type="checkbox"/> High pressure tyre	(22"-24"-25"-26")	<b>(Lightest configuration)</b>		
<input type="checkbox"/> High pressure profile tyre	(24")			
<input type="checkbox"/> Marathon Plus	(24"-25")	with anti-puncture protection	01669	£ 55
<input type="checkbox"/> Solid tyre Kik Mako - Colour Black	(24")		01041	£ 109
<input type="checkbox"/> Solid tyre Kik Mako - Colour Grey	(24")		01751	£ 109



<b>Handrim - Wheel distance</b>		<input checked="" type="checkbox"/> <b>3 cm</b>	<input type="checkbox"/> <b>4 cm</b>	
<input checked="" type="checkbox"/> Aluminium	(22"-24"-25"-26")	<b>(Lightest configuration)</b>		
<input type="checkbox"/> Aluminium black SOFT-TOUCH	(24"-25")		09170	£ 109
<input type="checkbox"/> Chromed Steel	(24"-25")		01684	£ 131
<input type="checkbox"/> Titanium	(24"-25")		00016	£ 240
<input type="checkbox"/> Ultra Grepp	(24"-25")		00017	£ 273
<input type="checkbox"/> Max Grepp	(24"-25")		00834	£ 305
<input type="checkbox"/> Ergo Para	(24")		00632	£ 305
<input type="checkbox"/> SURGE LT	(24"-25")	Oval countour with a rubber insert	06427	£ 316
<input type="checkbox"/> Quad (24")	(24")		00693	£ 175
<input type="checkbox"/> Silicon cover for standard aluminium handrim	Available for measures (22"-24"-25"-26")		04050	£ 142

<b>Wheel locks</b>				
<input checked="" type="checkbox"/> Without brake				
<input type="checkbox"/> Bent lever push to lock				
<input type="checkbox"/> Straight lever Push to lock				
<input type="checkbox"/> Straight lever Pull to lock				
<input type="checkbox"/> Sport brake		<b>(Lightest configuration)</b>		
<input type="checkbox"/> Brake with extension lever push to lock				
<input type="checkbox"/> Brake with extension lever pull to lock				

<b>Mudguard</b>				
<input checked="" type="checkbox"/> Carbon fibre mudguard				
<input type="checkbox"/> Carbon fibre Straight sideguard	<input checked="" type="checkbox"/> Aligned wheel	<input type="checkbox"/> Under wheel ..... cm	<input type="checkbox"/> Above wheel ..... cm	
<input type="checkbox"/> Removable carbon fibre mudguard				04109 £ 218
<input type="checkbox"/> Removable Carbon fibre straight sideguard	<input checked="" type="checkbox"/> Aligned wheel	<input type="checkbox"/> Under wheel ..... cm	<input type="checkbox"/> Above wheel ..... cm	04109 £ 218

<b>Armrests</b>				
<input type="checkbox"/> Swing away armrests	<b>(Swing away, removable and height adjustable armrest)</b>			00694 £ 218
	<input checked="" type="checkbox"/> Pad STANDARD			
	<input type="checkbox"/> Ergonomic pad (30x6 cm.)			04104 £ 55

<b>Accessories</b>				
<input type="checkbox"/> Pad for front frame protectors				07058 £ 44
<input type="checkbox"/> Removable storage bag (with quick coupling)				09811 £ 109

<b>Optional 1</b>				
<input type="checkbox"/> Transit wheels				03290 £ 131
<input type="checkbox"/> Anti-tipper with rapid hookup	<b>(inside rotation to reduce the encumbrance)</b>			
	<input type="checkbox"/> Right			06821 £ 109
	<input type="checkbox"/> Left			06822 £ 109



Rehateam s.r.l. Vicolo Negrelli, 5 - 31040 Castagnole di Paese (TV) - Tel. +39.0422.484657 / +39.0422.484661 / +39.0422.484684  
 P.IVA IT 03182520266 - C.C.I.A.A. TV n.225867 - Iscr. Trib. TV n.41690 Capitale Sociale L.V. Euro 100.000,00

Email: info@rehateamprogeo.com - web: http://www.rehateamprogeo.com

Date ..... Order ..... English User name ..... Address .....

<b>Optional 2</b>				
<input type="radio"/> Lumbar support	(to insert in the backrest upholstery)		00013	£ 33
<input type="radio"/> Tetraclip	(Quick release axle for quadriplegic)		03947	£ 153

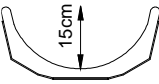
<b>Additional Kit</b>				
<input type="radio"/> 24" Off-road rear wheels	Off-Road tyre - aluminium handrim (black colour)		03378	£ 436
<input type="radio"/> 24" FAT rear wheels	FAT tyre 3" - aluminium handrim (black colour)		09357	£ 764

<b>PHYSIO - Posture backrest</b>		Std. Backrest upholstery not provided				
<input type="radio"/> Aluminum shell Lateral retaining STANDARD 7,5cm		Height <input type="checkbox"/> 25	<input type="checkbox"/> 33	<input type="checkbox"/> 41	05308	£ 884
		Height <input type="checkbox"/> 52	Lateral retaining wing <input type="checkbox"/> A=high <input type="checkbox"/> B=low		05309	£ 938
<input type="radio"/> Aluminum shell Lateral retaining DEEP 15cm		Height <input type="checkbox"/> 25	<input type="checkbox"/> 33	<input type="checkbox"/> 41	05310	£ 938
		Height <input type="checkbox"/> 52	Lateral retaining wing <input type="checkbox"/> A=high <input type="checkbox"/> B=low		05311	£ 993
<input type="radio"/> Carbon shell Lateral retaining STANDARD 7,5cm		Height <input type="checkbox"/> 25	<input type="checkbox"/> 33	<input type="checkbox"/> 41	05312	£ 1015
		Lateral retaining wing <input type="checkbox"/> A=high <input type="checkbox"/> B=low				

**COVER**

☆ Cover with fabric-cover of backrest's rear side and high refraction fabric hems



SWING AWAY - Lateral support  
Not available with Physio backrest with lateral retaining DEEP and in carbon backrest

Internal thoracic support to the backrest width, adjustable (0 ÷ -1,5cm)

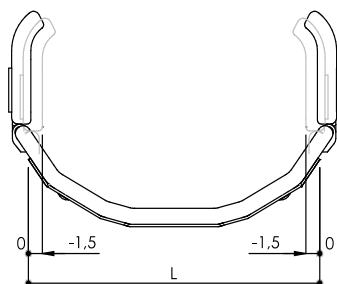

- Large (17,5x11,5)  
 Left 05646       Right 05647  
 Small (14x9,5)  
 Left 05642       Right 05643  
 Additional Kit for internal thoracic support to the backrest width, adjustable (-8,5 ÷ -10cm)

Internal thoracic support to the backrest width, adjustable (-4 ÷ -5,5cm)

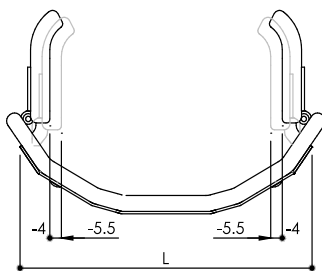

- Large (17,5x11,5)  
 Left 05646       Right 05647  
 Small (14x9,5)  
 Left 05642       Right 05643

Internal thoracic support to the backrest width, adjustable (-8,5 ÷ -10cm)

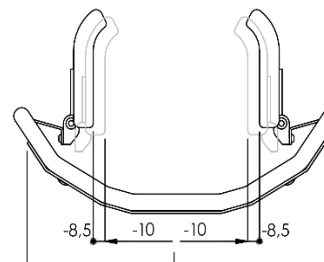

- Large (17,5x11,5)  
 Left 05646       Right 05647      £ 175  
 Small (14x9,5)  
 Left 05642       Right 05643      £ 175  
 (with additional kit)      £ 175

<input type="radio"/> Headrest adjustable - Double ball mounting system				
Not available for Physio backrest's height 25 and with carbon shell		<input type="checkbox"/> Large (34x14)	05648	£ 393
		<input type="checkbox"/> Small (28x14)		

Rehateam s.r.l. Vicolo Negrelli, 5 - 31040 Castagnole di Paese (TV) - Tel. +39.0422.484657 / +39.0422.480387 - Fax +39.0422.484661 / +39.0422.484664  
 P.IVA IT 03182520266 - C.C.I.A.A. TV n.225867 - Iscr.Trib. TV n.41690 Capitale Sociale I.V. Euro 100.000,00

Email: info@rehateamprogeo.com - web: http://www.rehateamprogeo.com

English

Date ..... Order ..... User name ..... Address .....

## REFERENCE TABLES

**IMPORTANT NOTICE** Keep attention to all measures.  
**NOIR is a wheelchair without possibilities of adjustments after its manufacturing.**  
**(1) The real seat depth, from the front part of the seat cloth to the backrest tube will be 1,5 cm more than the declared one.**

1	A Footplate width			
	DP	35÷39	40÷45	46÷50
LS				
33	21,5	21	20,5	
36	24,5	24	23,5	
39	27,5	27	26,5	
42	30,5	30	29,5	
45	33,5	33	32,5	
48	36,5	36	35,5	

2	Setting	C :
	Extremely prudential	7,5
	Prudential	9
	Standard	10,5
	Active	12
	Extreme	13,5

3	Maximum width
Camber	
0°	LS + 18
2°	LS + 21
4°	LS + 24

Maximum width calculated including 3 cm. distance between tyre and handrim

Italia Certified company normative UNI EN ISO 9001

Important notices page only if any optional have been chosen