

Data ..... Utilizzatore ..... Peso utilizzatore (kg) ..... Lingua manuale d'uso .....	Italia Timbro ditta Responsabile .....	Carrozzina rigida basculante  <b>€ 2600,00</b> <b>Schienale posturale Physio Posture compreso nel prezzo</b>
--	--	---

Informazioni sull'utilizzatore	
Patologia utilizzatore: .....	
Presenza di spasmi importanti o distonie: <input type="checkbox"/> SI <input type="checkbox"/> NO	Peso utilizzatore (kg):.....Kg

**Misure carrozzina - La tolleranza su tutte le dimensioni indicate e/o richieste è di ± 10 mm**

MODELLO ADULTO	MODELLO BAMBINO
<b>Larghezza sedile (LS)</b>	
<input type="checkbox"/> 33 <input type="checkbox"/> 36 <input type="checkbox"/> 39 <input type="checkbox"/> 42 <input type="checkbox"/> 45 <input type="checkbox"/> 48	<input type="checkbox"/> 33 <input type="checkbox"/> 36 <input type="checkbox"/> 39
Kit allargamento seduta (LS + 3cm) - fornito di serie ☆ Non montato (LS) <input type="checkbox"/> Montato (LS + 3cm)	Kit allargamento seduta (LS + 3cm) - fornito di serie ☆ Non montato (LS) <input type="checkbox"/> Montato (LS + 3cm)

Profondità sedile (PS) - regolabile!			Posizione tubo schienale
<b>Telaio corto</b> <input type="checkbox"/> 35 <input type="checkbox"/> 37,5 <input type="checkbox"/> 40	<b>Telaio medio</b> <input type="checkbox"/> 40 <input type="checkbox"/> 42,5 <input type="checkbox"/> 45	<b>Telaio lungo</b> <input type="checkbox"/> 45 <input type="checkbox"/> 47,5 <input type="checkbox"/> 50	
(PS 40)	(PS 45)	(PS 50)	

Distanza pedana (DP) - (Distanza tela sedile - piatto pedana)	
<i>ATTENZIONE! Altezza anteriore minimo 4 cm maggiore della DISTANZA PEDANA</i>	
<i>Distanza pedana minima possibile ~22cm</i>	
<input style="width: 50px;" type="text"/> (cm)	±0,5cm - step di regolazione 1,5cm

Altezza carrozzina (con seduta parallela al terreno)				
	Ruote posteriori			
	12"	16"	22"	24"
RUOTE ANTERIORI 6"	<input type="checkbox"/> 42		<input type="checkbox"/> 42	
	☆ 43,3		☆ 43,3	☆ 43,3
	<input type="checkbox"/> 44,5		<input type="checkbox"/> 44,5	<input type="checkbox"/> 44,5
	<input type="checkbox"/> 45,8		<input type="checkbox"/> 45,8	<input type="checkbox"/> 45,8
	<input type="checkbox"/> 47	<input type="checkbox"/> 47	<input type="checkbox"/> 47	<input type="checkbox"/> 47
	<input type="checkbox"/> 48,3	<input type="checkbox"/> 48,3	<input type="checkbox"/> 48,3	<input type="checkbox"/> 48,3
	Ruote posteriori			
	12"	16"	22"	24"
RUOTE ANTERIORI 7"	<input type="checkbox"/> 44,5		<input type="checkbox"/> 44,5	<input type="checkbox"/> 44,5
	<input type="checkbox"/> 45,8		<input type="checkbox"/> 45,8	<input type="checkbox"/> 45,8
	<input type="checkbox"/> 47	<input type="checkbox"/> 47	<input type="checkbox"/> 47	<input type="checkbox"/> 47
		<input type="checkbox"/> 48,3	<input type="checkbox"/> 48,3	<input type="checkbox"/> 48,3

Telaio anteriore	<b>Telaio anteriore girevole ed estraibile</b>
☆ Telaio dritto	 ☆ 110°
	 <input type="checkbox"/> 120°
	 <input type="checkbox"/> 95° (Esclude l'installazione delle ruote anteriori 7")
<input type="checkbox"/> Telaio con abduzione 6cm non disponibile per larghezza 42 - 45 - 48 Distanza pedana massima possibile 40	<b>Telaio anteriore girevole ed estraibile</b>
	 ☆ 95° (Non disponibile ruote anteriori 7")
<input type="checkbox"/> Telaio anteriore elevabile, girevole ed estraibile non disponibile per larghezza 33 Distanza pedana minima possibile 22cm.  Completo supporti polpaccio e di appoggiapiedi in plastica con fascia ferma talloni	 <b>09730    250,00</b>

Permobil Progeo Active Design s.r.l. - a Socio Unico - Vicolo L. Negrelli, 5 - 31038 Paese (TV) - Tel. +39 0422 484657  
 P.IVA, Codice Fiscale e Numero di iscrizione al Registro Imprese di Treviso 10246110968 - Fatturazione Elettronica, Codice Destinatario A4707H7 - Capitale Sociale i.v. € 10.000,00

Email: info\_it@permobil.com - web: http://www.rehateamprogeo.com

Data ..... Commessa ..... Utilizzatore ..... Indirizzo .....

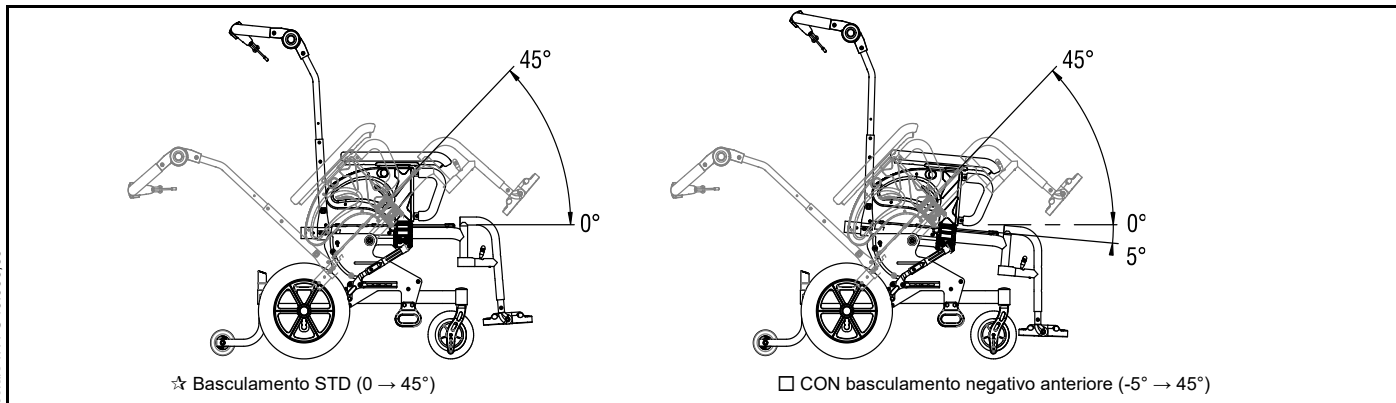

**SAFETY**  
 Sistema di ancoraggio a 4 punti per fissaggio carrozzina (l'installazione deve essere eseguita dalla casa costruttrice).  
 Installare un appoggiatesta idoneo per il trasporto e posizionarlo sempre adeguatamente durante il trasporto.

**CRASH TEST APPROVED**      08654      **190,00**

**Colore telaio (senza aggiunta di prezzo)**  
 ☆ Nero opaco      □ Blu AVIO      □ Bianco POLAR      □ Arancio Opaco  
                          □ Tekno antracite      □ Grigio opaco      □ Rosso opaco

**Colore telaio su richiesta**  
 Rosso brillante       Fucsia brillante       Lime brillante       Blu china brillante      **09729      220,00**

**Schienale**  
 ☆ Schienale reclinabile ed abbattibile  
 Regolazione rapida dell'inclinazione su tre posizioni

**Maniglione unico di spinta per accompagnatore**  
 Posizionamento libero      **01048      190,00**

Permette regolazione in altezza del maniglione in funzione dell'accompagnatore (indipendente dall'altezza schienale - regolazione rapida)

**SCHIENALE POSTURALE PHYSIO POSTURE COMPRESO NEL PREZZO**

Selezionare lo schienale desiderato a pagina 4

**Ruote anteriori**  
 ☆ 6" Piena Soft  
 6" Pneumatica  
 7" Piena Soft      Non disponibile con: Telaio anteriore 95°

**Ruote posteriori**  
 ☆ Ruote da transito da 12" - Copertura piena  
 Ruote da transito da 12" - Pneumatica  
 Ruote da transito da 16" - Pneumatica

<input type="radio"/> 24" Superleggera Standard Progeo		<b>04696      120,00</b>
<input type="radio"/> 22" Superleggera Standard Progeo		<b>04696      120,00</b>
<input type="radio"/> 24" Superleggera "Spinergy LX"		<b>04691      800,00</b>
<input type="radio"/> 24" Superleggera "Spinergy LXL"	<input type="checkbox"/> Raggi bianchi e mozzo nero	<b>07848      800,00</b>
<input type="radio"/> 24" Superleggera "Spinergy Flex rim"	<input type="checkbox"/> Corrimano incorporato Alluminio/Gomma	<b>02270      1.200,00</b>
<input type="radio"/> 24" Fuoristrada (corrimano in alluminio nero - Distanza ruota 4cm)		<b>04690      300,00</b>
<input type="radio"/> 12" con freno a tamburo per accompagnatore	<input type="checkbox"/> Copertura piena <input type="checkbox"/> Pneumatica	<b>04105      320,00</b>
<input type="radio"/> 16" con freno a tamburo per accompagnatore - Pneumatica		<b>04107      320,00</b>
<input type="radio"/> 24" con freno a tamburo per accompagnatore (corrimano in alluminio - Distanza ruota 3cm)		<b>03384      350,00</b>

**Colore ruote posteriori**  
 Solo le ruote standard Progeo 22"/24" hanno mozzi e cerchi colorati

☆ Nero	22" 24"	
<input type="radio"/> Argento brillante	22" 24"	<b>00833      130,00</b>
<input type="radio"/> Lime brillante	22" 24"	<b>00833      130,00</b>
<input type="radio"/> Azzurro brillante	22" 24"	<b>00833      130,00</b>
<input type="radio"/> Rosso brillante	22" 24"	<b>00833      130,00</b>
<input type="radio"/> Fucsia brillante	22" 24"	<b>00833      130,00</b>
<input type="radio"/> Bianco POLAR	22" 24"	<b>00833      130,00</b>
<input type="radio"/> Tekno antracite	22" 24"	<b>00833      130,00</b>
<input type="radio"/> Blu notte opaco	22" 24"	<b>00833      130,00</b>
<input type="radio"/> Grigio opaco	22" 24"	<b>00833      130,00</b>
<input type="radio"/> Rosso opaco	22" 24"	<b>00833      130,00</b>





Permobili Progeo Active Design s.r.l. - a Socio Unico - Vicolo L. Negrelli, 5 - 31038 Paese (TV) - Tel. +39 0422 484657  
 P.IVA, Codice Fiscale e Numero di iscrizione al Registro Imprese di Treviso 10246110968 - Fatturazione Elettronica - Codice Destinatario A4707H7 - Capitale Sociale I.V. € 10.000,00

E-mail: info\_it@permobil.com - web: http://www.rehateamprogeo.com

Data .....	Commessa .....	Utilizzatore .....	Indirizzo .....
------------	----------------	--------------------	-----------------

Cerchi di spinta	Distanza ruota <input checked="" type="checkbox"/> 3 cm <input type="checkbox"/> 4 cm		
<input checked="" type="radio"/> Alluminio	(22-24")		
<input type="radio"/> Alluminio Nero SOFT-TOUCH	(24")	09170	110,00
<input type="radio"/> Acciaio cromato	(24")	01684	170,00
<input type="radio"/> Titanio	(24")	00016	270,00
<input type="radio"/> Ultra Grepp	(24")	00017	300,00
<input type="radio"/> TOP FRICTION	(24")	11023	290,00
Profilo ovale con inserto in gomma			
<input type="radio"/> NOVA H	(24")	11025	270,00
Profilo ergonomico colore nero			
<input type="radio"/> NOVA D	(24")	11026	290,00
Profilo ergonomico con rivestimento in gomma (ideale per tetraplegici)			
<input type="radio"/> Anello anti scivolo in silicone applicabile su cerchio in alluminio		04050	170,00





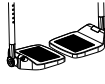
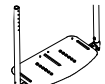

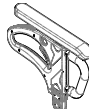
Copertura ruota posteriore			
<input checked="" type="radio"/> Liscio Alta Pressione	(22-24")		
<input type="checkbox"/> Tassellato Alta Pressione	(24")		
<input type="radio"/> Marathon Plus	(24")	con protezione anti foratura	01669 90,00
<input type="radio"/> Copertura piena - Colore Grigio	(22")		04181 110,00
<input type="radio"/> Copertura piena - Colore Nero	(24")		11083 110,00
<b>Non disponibile con Ruote posteriori: 24" Superleggere "Spinergy LXL"</b>			

Freni			
<input checked="" type="radio"/> Freno leva curva da spingere			
<input type="checkbox"/> Freno leva dritta da spingere			
<input type="checkbox"/> Freno leva dritta da tirare			
<input type="radio"/> Freno con leva prolungata da spingere			01949 70,00
<input type="radio"/> Freno con leva prolungata da tirare			03372 70,00

Pedana (Non disponibile con Telaio anteriore elevabile, girevole ed estraibile)			
<input checked="" type="radio"/> Pedana sdoppiata in plastica, regolabile in inclinazione			11525
Distanza pedana minima possibile ~19cm			
Non disponibile con: Telaio anteriore con pedana elevabile, girevole ed estraibile			
<input type="radio"/> Pedana unica alzabile in alluminio regolabile in profondità e inclinazione			09727 130,00
Distanza pedana minima possibile ~18cm			
Non disponibile con: Telaio anteriore con pedana elevabile, girevole ed estraibile			
	<input type="checkbox"/> interna	<input checked="" type="checkbox"/> 2/3 interna	<input type="checkbox"/> 2/3 esterna
			<input type="checkbox"/> esterna

Braccioli estraibili CON protezione vestiario integrata			
<input checked="" type="radio"/> Braccioli Desk PROGEO	(Estraibili regolabili in altezza)		

Accessori			
<input type="radio"/> Imbottitura paracolpi telaio anteriore		07058	50,00
<input type="radio"/> Borsello portaoggetti removibile (con aggancio rapido)		09811	120,00

Optional 1			
<input checked="" type="radio"/> Antiribaltamento con Aiutoribaltamento integrato (rotazione all'interno per ridurre l'ingombro)			
<i>FORNITE DI SERIE</i>			
<input type="radio"/> Ruote antiribaltamento con aggancio rapido	(rotazione all'interno per ridurre l'ingombro)		11033 150,00
<input type="radio"/> Ruote ascensore			00836 170,00
<input type="radio"/> Aiuto ribaltamento	<input type="radio"/> Destro		00025 90,00
	<input type="radio"/> Sinistro		01046 90,00
<input type="radio"/> Porta stampelle	<input type="radio"/> Destro		00838 80,00
	<input type="radio"/> Sinistro		00837 80,00

Optional 2			
<input type="radio"/> Cinghia di bretellaggio		04103	130,00
<input type="radio"/> Cinghia pelvica di ancoraggio		03972	70,00
<input type="radio"/> Tavolino (estraibile)		00508	260,00
<input type="radio"/> Supporto lombare	(da inserire all'interno dello schienale)	00013	50,00
<input type="radio"/> Copriraggi Nero	(22-24")	01043	160,00
<input type="radio"/> Copriraggi Trasparente	(22-24")	00835	160,00
<input type="radio"/> Copriraggi Colorato Progeo Design	(22-24")	00019	180,00

Permobili Progeo Active Design s.r.l. - a Socio Unico - Vicolo L. Negrelli, 5 - 31038 Pease (TV) - Tel. +39 0422 484657  
 P.IVA, Codice Fiscale e Numero di iscrizione al Registro Imprese di Treviso 10246110968 - Fatturazione Elettronica: Codice Destinatario A4707H7 - Capitale Sociale I.V. € 10.000,00





Email: info\_it@permobili.com - web: http://www.rehateamprogeo.com

Data ..... Comnessa ..... Utilizzatore ..... Indirizzo .....

**PHYSIO - Schienale posturale integrato (NON REMOVIBILE)**

Installazione su tubi diametro 18÷26mm  
Regolazione in profondità (3cm)  
Regolazione inclinazione (±18°)

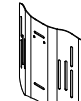
☆ **POSTURE** Guscio ALLUMINIO

ALTEZZA SCHIENALE	34	40	52
Conformazione del guscio 	Ala di contenimento laterale R=regolare		
	<b>R</b>	<b>R</b>	<b>R</b>
			

**Configurazione DEEP con PAD per contenimento laterale (regolabili in altezza)**



Pad in alluminio con imbottitura e rivestimento in tessuto traspirante



	Piccolo (h 13cm)		Grande (h 20cm)	
		<input type="radio"/> Destro 10272		<input type="radio"/> Destro 10273
		40,00		50,00
		<input type="radio"/> Sinistro 10272		<input type="radio"/> Sinistro 10273
		40,00		50,00

**Accessori**

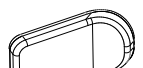
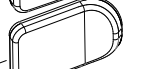
○ Supporti toracici (spinta laterale) - SWING AWAY - Girevole  
Hardware di fissaggio e regolazione completi di imbottitura paracolpi  
Pad in alluminio con imbottitura e rivestimento in tessuto traspirante

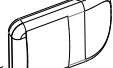
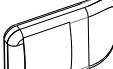
	<input type="radio"/> Grande (18x12)	05647	170,00
	<input type="radio"/> Piccola (14x9)	05643	170,00
	<input type="radio"/> Prolunga supporto toracico	Quantità (n° pz).....	10271 60,00
	<input type="radio"/> Prolunga supporto toracico	Quantità (n° pz).....	
	<input type="radio"/> Piccola (14x9)	05642	170,00
	<input type="radio"/> Grande (18x12)	05646	170,00

○ Poggiatesta multiregolazione - sistema di montaggio a doppia sfera  
Disponibile solo su schienale Physio Posture e Kid







<input type="checkbox"/> Grande (35x12,5)	05648	360,00
<input type="checkbox"/> Piccola (25x12,5)		

Permobil Progeo Active Design s.r.l. - a Socio Unico - Vicolo L. Negrelli, 5 - 31038 Paese (TV) - Tel. +39 0422 484657  
P.IVA, Codice Fiscale e Numero di iscrizione al Registro Imprese di Treviso 10246110968 - Fatturazione Elettronica: Codice Destinatario A4707H7 - Capitale Sociale I.V. € 10.000,00

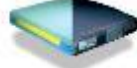
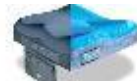
Email: info\_it@permobil.com - web: http://www.rehateamprogeo.com

Data ..... Comnessa ..... Utilizzatore ..... Indirizzo .....

**Cuscini antidecubito e posturali a nido d'ape STIMULITE**

<input type="radio"/> Classic H 7 cm.	<input type="checkbox"/> 36x41 <b>00035</b> <input type="checkbox"/> 41x46 <b>00840</b>	<input type="checkbox"/> 38x38 <b>00036</b> <input type="checkbox"/> 46x41 <b>00698</b>	<input type="checkbox"/> 38x41 <b>01052</b> <input type="checkbox"/> 46x46 <b>00038</b>	<input type="checkbox"/> 41x41 <b>00037</b>		<b>630,00</b>
<input type="radio"/> Anatomico Posturale H 9 cm. H 5cm. nella zona ischiatica	<input type="checkbox"/> 36x41 <b>00056</b> <input type="checkbox"/> 41x46 <b>01050</b>	<input type="checkbox"/> 38x38 <b>00696</b> <input type="checkbox"/> 46x41 <b>00034</b>	<input type="checkbox"/> 38x41 <b>00032</b> <input type="checkbox"/> 46x46 <b>01051</b>	<input type="checkbox"/> 41x41 <b>00033</b>		<b>630,00</b>
<input type="radio"/> Slimline sagomato H 7 cm. H 5cm. nella zona ischiatica	<input type="checkbox"/> 36x41 <b>00854</b> <input type="checkbox"/> 41x46 <b>00085</b>	<input type="checkbox"/> 38x38 <b>00707</b> <input type="checkbox"/> 46x41 <b>01074</b>	<input type="checkbox"/> 38x41 <b>00083</b> <input type="checkbox"/> 46x46 <b>01075</b>	<input type="checkbox"/> 41x41 <b>01073</b>		<b>630,00</b>
<input type="radio"/> Sport H 5 cm.	<input type="checkbox"/> 36x41 <b>00053</b> <input type="checkbox"/> 41x46 <b>00057</b>	<input type="checkbox"/> 38x38 <b>00054</b> <input type="checkbox"/> 46x41 <b>01062</b>	<input type="checkbox"/> 38x41 <b>01060</b> <input type="checkbox"/> 46x46 <b>00846</b>	<input type="checkbox"/> 41x41 <b>01061</b>		<b>630,00</b>
<input type="radio"/> Silver H 3,5 cm.	<input type="checkbox"/> 41x41 <b>00641</b>	<input type="checkbox"/> 41x46 <b>01353</b>	<input type="checkbox"/> 46x41 <b>00642</b>	<input type="checkbox"/> 46x46 <b>01022</b>		<b>630,00</b>
<input type="radio"/> Corbee Pediatrico H 5 cm.		<input type="checkbox"/> 30x30 <b>00845</b>	<input type="checkbox"/> 36x36 <b>00079</b>			<b>630,00</b>
<input type="radio"/> Pediatrico anatomico posturale H 6 cm. H 5cm. nella zona ischiatica		<input type="checkbox"/> 30x30 <b>01351</b>	<input type="checkbox"/> 36x36 <b>00639</b>			<b>630,00</b>

Misura cliente Larghezza cm. .... Profondità cm. ....

<input type="radio"/> Supporto lombare STIMULITE		<b>00064</b>	<b>220,00</b>
--	---	--------------	---------------







**Note**

Area for notes and additional specifications.

Permobil Progeo Active Design s.r.l. - a Socio Unico - Vicolo L. Negrelli, 5 - 31038 Pease (TV) - Tel. +39 0422 484657  
 P.IVA, Codice Fiscale e Numero di iscrizione al Registro Imprese di Treviso 10246110968 - Fatturazione Elettronica: Codice Destinatario A4707H7 - Capitale Sociale I.V. € 10.000,00

Email: info\_it@permobil.com - web: http://www.rehateamprogeo.com

Carrozzina : Progeo EASY TILT SMART - Rev. 2026.0	Prezzo IVA esclusa	<input checked="" type="checkbox"/> <b>standard</b> (fornito in assenza di altre indicazioni) <input type="checkbox"/> <b>su richiesta</b> (senza aggiunta di prezzo) <input type="checkbox"/> <b>optional</b> (sommare il prezzo a quello di listino)	
	da sommare al prezzo di listino		

Data	Commessa	Utilizzatore	Indirizzo																																																																								
<b>ROHO® MOSAIC® - H7cm - Limite di peso 143Kg</b> <span style="float: right;"><b>200,00</b></span>																																																																											
<table border="1"> <thead> <tr> <th>Misure cuscino LxP</th> <th>Adatto a seduta LxSxPS</th> <th>Codice</th> </tr> </thead> <tbody> <tr><td><input type="checkbox"/> 41 x 41</td><td>42 x 42</td><td>MOS1616HD</td></tr> <tr><td><input type="checkbox"/> 41 x 46</td><td>42 x 47</td><td>MOS1618HD</td></tr> <tr><td><input type="checkbox"/> 44 x 44</td><td>44 x 44</td><td>MOS1717HD</td></tr> </tbody> </table>	Misure cuscino LxP	Adatto a seduta LxSxPS	Codice	<input type="checkbox"/> 41 x 41	42 x 42	MOS1616HD	<input type="checkbox"/> 41 x 46	42 x 47	MOS1618HD	<input type="checkbox"/> 44 x 44	44 x 44	MOS1717HD	<table border="1"> <thead> <tr> <th>Misure cuscino LxP</th> <th>Adatto a seduta LxSxPS</th> <th>Codice</th> </tr> </thead> <tbody> <tr><td><input type="checkbox"/> 46 x 41</td><td>47 x 42</td><td>MOS1816HD</td></tr> <tr><td><input type="checkbox"/> 46 x 46</td><td>47 x 47</td><td>MOS1818HD</td></tr> <tr><td><input type="checkbox"/> 51 x 46</td><td>52 x 47</td><td>MOS2018HD</td></tr> </tbody> </table>	Misure cuscino LxP	Adatto a seduta LxSxPS	Codice	<input type="checkbox"/> 46 x 41	47 x 42	MOS1816HD	<input type="checkbox"/> 46 x 46	47 x 47	MOS1818HD	<input type="checkbox"/> 51 x 46	52 x 47	MOS2018HD																																																		
Misure cuscino LxP	Adatto a seduta LxSxPS	Codice																																																																									
<input type="checkbox"/> 41 x 41	42 x 42	MOS1616HD																																																																									
<input type="checkbox"/> 41 x 46	42 x 47	MOS1618HD																																																																									
<input type="checkbox"/> 44 x 44	44 x 44	MOS1717HD																																																																									
Misure cuscino LxP	Adatto a seduta LxSxPS	Codice																																																																									
<input type="checkbox"/> 46 x 41	47 x 42	MOS1816HD																																																																									
<input type="checkbox"/> 46 x 46	47 x 47	MOS1818HD																																																																									
<input type="checkbox"/> 51 x 46	52 x 47	MOS2018HD																																																																									
<b>ROHO® AIR LITE® - H9,5cm - Limite di peso 136Kg</b> <span style="float: right;"><b>200,00</b></span>																																																																											
<table border="1"> <thead> <tr> <th>Misure cuscino LxP</th> <th>Codice</th> </tr> </thead> <tbody> <tr><td><input type="checkbox"/> 33 x 33</td><td>AL1313HD</td></tr> <tr><td><input type="checkbox"/> 33 x 38</td><td>AL1315HD</td></tr> <tr><td><input type="checkbox"/> 36 x 36</td><td>AL1414HD</td></tr> <tr><td><input type="checkbox"/> 36 x 41</td><td>AL1416HD</td></tr> <tr><td><input type="checkbox"/> 38 x 38</td><td>AL1515HD</td></tr> <tr><td><input type="checkbox"/> 38 x 43</td><td>AL1517HD</td></tr> <tr><td><input type="checkbox"/> 41 x 41</td><td>AL1616HD</td></tr> <tr><td><input type="checkbox"/> 41 x 46</td><td>AL1618HD</td></tr> <tr><td><input type="checkbox"/> 43 x 43</td><td>AL1717HD</td></tr> </tbody> </table>	Misure cuscino LxP	Codice	<input type="checkbox"/> 33 x 33	AL1313HD	<input type="checkbox"/> 33 x 38	AL1315HD	<input type="checkbox"/> 36 x 36	AL1414HD	<input type="checkbox"/> 36 x 41	AL1416HD	<input type="checkbox"/> 38 x 38	AL1515HD	<input type="checkbox"/> 38 x 43	AL1517HD	<input type="checkbox"/> 41 x 41	AL1616HD	<input type="checkbox"/> 41 x 46	AL1618HD	<input type="checkbox"/> 43 x 43	AL1717HD	<table border="1"> <thead> <tr> <th>Misure cuscino LxP</th> <th>Codice</th> </tr> </thead> <tbody> <tr><td><input type="checkbox"/> 43 x 46</td><td>AL1718HD</td></tr> <tr><td><input type="checkbox"/> 43 x 51</td><td>AL1720HD</td></tr> <tr><td><input type="checkbox"/> 46 x 41</td><td>AL1816HD</td></tr> <tr><td><input type="checkbox"/> 46 x 46</td><td>AL1818HD</td></tr> <tr><td><input type="checkbox"/> 46 x 51</td><td>AL1820HD</td></tr> <tr><td><input type="checkbox"/> 48 x 43</td><td>AL1917HD</td></tr> <tr><td><input type="checkbox"/> 48 x 48</td><td>AL1919HD</td></tr> <tr><td><input type="checkbox"/> 51 x 43</td><td>AL2017HD</td></tr> <tr><td><input type="checkbox"/> 51 x 46</td><td>AL2018HD</td></tr> </tbody> </table>	Misure cuscino LxP	Codice	<input type="checkbox"/> 43 x 46	AL1718HD	<input type="checkbox"/> 43 x 51	AL1720HD	<input type="checkbox"/> 46 x 41	AL1816HD	<input type="checkbox"/> 46 x 46	AL1818HD	<input type="checkbox"/> 46 x 51	AL1820HD	<input type="checkbox"/> 48 x 43	AL1917HD	<input type="checkbox"/> 48 x 48	AL1919HD	<input type="checkbox"/> 51 x 43	AL2017HD	<input type="checkbox"/> 51 x 46	AL2018HD																																		
Misure cuscino LxP	Codice																																																																										
<input type="checkbox"/> 33 x 33	AL1313HD																																																																										
<input type="checkbox"/> 33 x 38	AL1315HD																																																																										
<input type="checkbox"/> 36 x 36	AL1414HD																																																																										
<input type="checkbox"/> 36 x 41	AL1416HD																																																																										
<input type="checkbox"/> 38 x 38	AL1515HD																																																																										
<input type="checkbox"/> 38 x 43	AL1517HD																																																																										
<input type="checkbox"/> 41 x 41	AL1616HD																																																																										
<input type="checkbox"/> 41 x 46	AL1618HD																																																																										
<input type="checkbox"/> 43 x 43	AL1717HD																																																																										
Misure cuscino LxP	Codice																																																																										
<input type="checkbox"/> 43 x 46	AL1718HD																																																																										
<input type="checkbox"/> 43 x 51	AL1720HD																																																																										
<input type="checkbox"/> 46 x 41	AL1816HD																																																																										
<input type="checkbox"/> 46 x 46	AL1818HD																																																																										
<input type="checkbox"/> 46 x 51	AL1820HD																																																																										
<input type="checkbox"/> 48 x 43	AL1917HD																																																																										
<input type="checkbox"/> 48 x 48	AL1919HD																																																																										
<input type="checkbox"/> 51 x 43	AL2017HD																																																																										
<input type="checkbox"/> 51 x 46	AL2018HD																																																																										
<b>ROHO® HYBRID ELITE SR® - Monovalvola - Sensor Ready - Limite di peso 225Kg</b> <span style="float: right;"><b>630,00</b></span>																																																																											
<table border="1"> <thead> <tr> <th>Misure cuscino LxP</th> <th>Adatto a seduta LxSxPS</th> <th>Codice</th> </tr> </thead> <tbody> <tr><td><input type="checkbox"/> 35 x 37,5</td><td>36 x 36</td><td>1RHE1414C-SR</td></tr> <tr><td><input type="checkbox"/> 35 x 40</td><td>36 x 38</td><td>1RHE1415C-SR</td></tr> <tr><td><input type="checkbox"/> 35 x 43</td><td>36 x 41</td><td>1RHE1416C-SR</td></tr> <tr><td><input type="checkbox"/> 37,5 x 40</td><td>38 x 38</td><td>1RHE1515C-SR</td></tr> <tr><td><input type="checkbox"/> 37,5 x 43</td><td>38 x 41</td><td>1RHE1516C-SR</td></tr> <tr><td><input type="checkbox"/> 37,5 x 45</td><td>38 x 43</td><td>1RHE1517C-SR</td></tr> <tr><td><input type="checkbox"/> 40 x 40</td><td>41 x 38</td><td>1RHE1615C-SR</td></tr> <tr><td><input type="checkbox"/> 40 x 43</td><td>41 x 41</td><td>1RHE1616C-SR</td></tr> <tr><td><input type="checkbox"/> 40 x 45</td><td>41 x 43</td><td>1RHE1617C-SR</td></tr> <tr><td><input type="checkbox"/> 40 x 48</td><td>41 x 46</td><td>1RHE1618C-SR</td></tr> <tr><td><input type="checkbox"/> 40 x 53</td><td>41 x 51</td><td>1RHE1620C-SR</td></tr> </tbody> </table>	Misure cuscino LxP	Adatto a seduta LxSxPS	Codice	<input type="checkbox"/> 35 x 37,5	36 x 36	1RHE1414C-SR	<input type="checkbox"/> 35 x 40	36 x 38	1RHE1415C-SR	<input type="checkbox"/> 35 x 43	36 x 41	1RHE1416C-SR	<input type="checkbox"/> 37,5 x 40	38 x 38	1RHE1515C-SR	<input type="checkbox"/> 37,5 x 43	38 x 41	1RHE1516C-SR	<input type="checkbox"/> 37,5 x 45	38 x 43	1RHE1517C-SR	<input type="checkbox"/> 40 x 40	41 x 38	1RHE1615C-SR	<input type="checkbox"/> 40 x 43	41 x 41	1RHE1616C-SR	<input type="checkbox"/> 40 x 45	41 x 43	1RHE1617C-SR	<input type="checkbox"/> 40 x 48	41 x 46	1RHE1618C-SR	<input type="checkbox"/> 40 x 53	41 x 51	1RHE1620C-SR	<table border="1"> <thead> <tr> <th>Misure cuscino LxP</th> <th>Adatto a seduta LxSxPS</th> <th>Codice</th> </tr> </thead> <tbody> <tr><td><input type="checkbox"/> 43 x 43</td><td>43 x 41</td><td>1RHE1716C-SR</td></tr> <tr><td><input type="checkbox"/> 43 x 45</td><td>43 x 43</td><td>1RHE1717C-SR</td></tr> <tr><td><input type="checkbox"/> 43 x 48</td><td>43 x 46</td><td>1RHE1718C-SR</td></tr> <tr><td><input type="checkbox"/> 43 x 53</td><td>43 x 51</td><td>1RHE1720C-SR</td></tr> <tr><td><input type="checkbox"/> 45 x 43</td><td>46 x 41</td><td>1RHE1816C-SR</td></tr> <tr><td><input type="checkbox"/> 45 x 45</td><td>46 x 43</td><td>1RHE1817C-SR</td></tr> <tr><td><input type="checkbox"/> 45 x 48</td><td>46 x 46</td><td>1RHE1818C-SR</td></tr> <tr><td><input type="checkbox"/> 45 x 53</td><td>46 x 51</td><td>1RHE1820C-SR</td></tr> <tr><td><input type="checkbox"/> 50 x 45</td><td>51 x 43</td><td>1RHE2017C-SR</td></tr> <tr><td><input type="checkbox"/> 50 x 48</td><td>51 x 46</td><td>1RHE2018C-SR</td></tr> <tr><td><input type="checkbox"/> 50 x 53</td><td>51 x 51</td><td>1RHE2020C-SR</td></tr> </tbody> </table>	Misure cuscino LxP	Adatto a seduta LxSxPS	Codice	<input type="checkbox"/> 43 x 43	43 x 41	1RHE1716C-SR	<input type="checkbox"/> 43 x 45	43 x 43	1RHE1717C-SR	<input type="checkbox"/> 43 x 48	43 x 46	1RHE1718C-SR	<input type="checkbox"/> 43 x 53	43 x 51	1RHE1720C-SR	<input type="checkbox"/> 45 x 43	46 x 41	1RHE1816C-SR	<input type="checkbox"/> 45 x 45	46 x 43	1RHE1817C-SR	<input type="checkbox"/> 45 x 48	46 x 46	1RHE1818C-SR	<input type="checkbox"/> 45 x 53	46 x 51	1RHE1820C-SR	<input type="checkbox"/> 50 x 45	51 x 43	1RHE2017C-SR	<input type="checkbox"/> 50 x 48	51 x 46	1RHE2018C-SR	<input type="checkbox"/> 50 x 53	51 x 51	1RHE2020C-SR		
Misure cuscino LxP	Adatto a seduta LxSxPS	Codice																																																																									
<input type="checkbox"/> 35 x 37,5	36 x 36	1RHE1414C-SR																																																																									
<input type="checkbox"/> 35 x 40	36 x 38	1RHE1415C-SR																																																																									
<input type="checkbox"/> 35 x 43	36 x 41	1RHE1416C-SR																																																																									
<input type="checkbox"/> 37,5 x 40	38 x 38	1RHE1515C-SR																																																																									
<input type="checkbox"/> 37,5 x 43	38 x 41	1RHE1516C-SR																																																																									
<input type="checkbox"/> 37,5 x 45	38 x 43	1RHE1517C-SR																																																																									
<input type="checkbox"/> 40 x 40	41 x 38	1RHE1615C-SR																																																																									
<input type="checkbox"/> 40 x 43	41 x 41	1RHE1616C-SR																																																																									
<input type="checkbox"/> 40 x 45	41 x 43	1RHE1617C-SR																																																																									
<input type="checkbox"/> 40 x 48	41 x 46	1RHE1618C-SR																																																																									
<input type="checkbox"/> 40 x 53	41 x 51	1RHE1620C-SR																																																																									
Misure cuscino LxP	Adatto a seduta LxSxPS	Codice																																																																									
<input type="checkbox"/> 43 x 43	43 x 41	1RHE1716C-SR																																																																									
<input type="checkbox"/> 43 x 45	43 x 43	1RHE1717C-SR																																																																									
<input type="checkbox"/> 43 x 48	43 x 46	1RHE1718C-SR																																																																									
<input type="checkbox"/> 43 x 53	43 x 51	1RHE1720C-SR																																																																									
<input type="checkbox"/> 45 x 43	46 x 41	1RHE1816C-SR																																																																									
<input type="checkbox"/> 45 x 45	46 x 43	1RHE1817C-SR																																																																									
<input type="checkbox"/> 45 x 48	46 x 46	1RHE1818C-SR																																																																									
<input type="checkbox"/> 45 x 53	46 x 51	1RHE1820C-SR																																																																									
<input type="checkbox"/> 50 x 45	51 x 43	1RHE2017C-SR																																																																									
<input type="checkbox"/> 50 x 48	51 x 46	1RHE2018C-SR																																																																									
<input type="checkbox"/> 50 x 53	51 x 51	1RHE2020C-SR																																																																									
<b>ROHO® HYBRID ELITE® - Bivalvola /Bicompartimento - Limite di peso 225Kg</b> <span style="float: right;"><b>630,00</b></span>																																																																											
<table border="1"> <thead> <tr> <th>Misure cuscino LxP</th> <th>Adatto a seduta LxSxPS</th> <th>Codice</th> </tr> </thead> <tbody> <tr><td><input type="checkbox"/> 35 x 37,5</td><td>36 x 36</td><td>2RHE1414C</td></tr> <tr><td><input type="checkbox"/> 35 x 40</td><td>36 x 38</td><td>2RHE1415C</td></tr> <tr><td><input type="checkbox"/> 35 x 43</td><td>36 x 41</td><td>2RHE1416C</td></tr> <tr><td><input type="checkbox"/> 37,5 x 40</td><td>38 x 38</td><td>2RHE1515C</td></tr> <tr><td><input type="checkbox"/> 37,5 x 43</td><td>38 x 41</td><td>2RHE1516C</td></tr> <tr><td><input type="checkbox"/> 37,5 x 45</td><td>38 x 43</td><td>2RHE1517C</td></tr> <tr><td><input type="checkbox"/> 40 x 40</td><td>41 x 38</td><td>2RHE1615C</td></tr> <tr><td><input type="checkbox"/> 40 x 43</td><td>41 x 41</td><td>2RHE1616C</td></tr> <tr><td><input type="checkbox"/> 40 x 45</td><td>41 x 43</td><td>2RHE1617C</td></tr> <tr><td><input type="checkbox"/> 40 x 48</td><td>41 x 46</td><td>2RHE1618C</td></tr> <tr><td><input type="checkbox"/> 40 x 53</td><td>41 x 51</td><td>2RHE1620C</td></tr> </tbody> </table>	Misure cuscino LxP	Adatto a seduta LxSxPS	Codice	<input type="checkbox"/> 35 x 37,5	36 x 36	2RHE1414C	<input type="checkbox"/> 35 x 40	36 x 38	2RHE1415C	<input type="checkbox"/> 35 x 43	36 x 41	2RHE1416C	<input type="checkbox"/> 37,5 x 40	38 x 38	2RHE1515C	<input type="checkbox"/> 37,5 x 43	38 x 41	2RHE1516C	<input type="checkbox"/> 37,5 x 45	38 x 43	2RHE1517C	<input type="checkbox"/> 40 x 40	41 x 38	2RHE1615C	<input type="checkbox"/> 40 x 43	41 x 41	2RHE1616C	<input type="checkbox"/> 40 x 45	41 x 43	2RHE1617C	<input type="checkbox"/> 40 x 48	41 x 46	2RHE1618C	<input type="checkbox"/> 40 x 53	41 x 51	2RHE1620C	<table border="1"> <thead> <tr> <th>Misure cuscino LxP</th> <th>Adatto a seduta LxSxPS</th> <th>Codice</th> </tr> </thead> <tbody> <tr><td><input type="checkbox"/> 43 x 43</td><td>43 x 41</td><td>2RHE1716C</td></tr> <tr><td><input type="checkbox"/> 43 x 45</td><td>43 x 43</td><td>2RHE1717C</td></tr> <tr><td><input type="checkbox"/> 43 x 48</td><td>43 x 46</td><td>2RHE1718C</td></tr> <tr><td><input type="checkbox"/> 43 x 53</td><td>43 x 51</td><td>2RHE1720C</td></tr> <tr><td><input type="checkbox"/> 45 x 43</td><td>46 x 41</td><td>2RHE1816C</td></tr> <tr><td><input type="checkbox"/> 45 x 45</td><td>46 x 43</td><td>2RHE1817C</td></tr> <tr><td><input type="checkbox"/> 45 x 48</td><td>46 x 46</td><td>2RHE1818C</td></tr> <tr><td><input type="checkbox"/> 45 x 53</td><td>46 x 51</td><td>2RHE1820C</td></tr> <tr><td><input type="checkbox"/> 50 x 45</td><td>51 x 43</td><td>2RHE2017C</td></tr> <tr><td><input type="checkbox"/> 50 x 48</td><td>51 x 46</td><td>2RHE2018C</td></tr> <tr><td><input type="checkbox"/> 50 x 53</td><td>51 x 51</td><td>2RHE2020C</td></tr> </tbody> </table>	Misure cuscino LxP	Adatto a seduta LxSxPS	Codice	<input type="checkbox"/> 43 x 43	43 x 41	2RHE1716C	<input type="checkbox"/> 43 x 45	43 x 43	2RHE1717C	<input type="checkbox"/> 43 x 48	43 x 46	2RHE1718C	<input type="checkbox"/> 43 x 53	43 x 51	2RHE1720C	<input type="checkbox"/> 45 x 43	46 x 41	2RHE1816C	<input type="checkbox"/> 45 x 45	46 x 43	2RHE1817C	<input type="checkbox"/> 45 x 48	46 x 46	2RHE1818C	<input type="checkbox"/> 45 x 53	46 x 51	2RHE1820C	<input type="checkbox"/> 50 x 45	51 x 43	2RHE2017C	<input type="checkbox"/> 50 x 48	51 x 46	2RHE2018C	<input type="checkbox"/> 50 x 53	51 x 51	2RHE2020C		
Misure cuscino LxP	Adatto a seduta LxSxPS	Codice																																																																									
<input type="checkbox"/> 35 x 37,5	36 x 36	2RHE1414C																																																																									
<input type="checkbox"/> 35 x 40	36 x 38	2RHE1415C																																																																									
<input type="checkbox"/> 35 x 43	36 x 41	2RHE1416C																																																																									
<input type="checkbox"/> 37,5 x 40	38 x 38	2RHE1515C																																																																									
<input type="checkbox"/> 37,5 x 43	38 x 41	2RHE1516C																																																																									
<input type="checkbox"/> 37,5 x 45	38 x 43	2RHE1517C																																																																									
<input type="checkbox"/> 40 x 40	41 x 38	2RHE1615C																																																																									
<input type="checkbox"/> 40 x 43	41 x 41	2RHE1616C																																																																									
<input type="checkbox"/> 40 x 45	41 x 43	2RHE1617C																																																																									
<input type="checkbox"/> 40 x 48	41 x 46	2RHE1618C																																																																									
<input type="checkbox"/> 40 x 53	41 x 51	2RHE1620C																																																																									
Misure cuscino LxP	Adatto a seduta LxSxPS	Codice																																																																									
<input type="checkbox"/> 43 x 43	43 x 41	2RHE1716C																																																																									
<input type="checkbox"/> 43 x 45	43 x 43	2RHE1717C																																																																									
<input type="checkbox"/> 43 x 48	43 x 46	2RHE1718C																																																																									
<input type="checkbox"/> 43 x 53	43 x 51	2RHE1720C																																																																									
<input type="checkbox"/> 45 x 43	46 x 41	2RHE1816C																																																																									
<input type="checkbox"/> 45 x 45	46 x 43	2RHE1817C																																																																									
<input type="checkbox"/> 45 x 48	46 x 46	2RHE1818C																																																																									
<input type="checkbox"/> 45 x 53	46 x 51	2RHE1820C																																																																									
<input type="checkbox"/> 50 x 45	51 x 43	2RHE2017C																																																																									
<input type="checkbox"/> 50 x 48	51 x 46	2RHE2018C																																																																									
<input type="checkbox"/> 50 x 53	51 x 51	2RHE2020C																																																																									
<b>ROHO® HYBRID SELECT®</b> <span style="float: right;"><b>630,00</b></span>																																																																											
<table border="1"> <thead> <tr> <th>Misure cuscino LxP</th> <th>Adatto a seduta LxSxPS</th> <th>Codice</th> </tr> </thead> <tbody> <tr><td><input type="checkbox"/> 35,5 x 37,5</td><td>36x38</td><td>HS1414C</td></tr> <tr><td><input type="checkbox"/> 35,5 x 42,5</td><td>36x43</td><td>HS1416C</td></tr> <tr><td><input type="checkbox"/> 38 x 40</td><td>38x40</td><td>HS1515C</td></tr> <tr><td><input type="checkbox"/> 38 x 42,5</td><td>38x43</td><td>HS1516C</td></tr> <tr><td><input type="checkbox"/> 38 x 45</td><td>38x45</td><td>HS1517C</td></tr> <tr><td><input type="checkbox"/> 40,5 x 40</td><td>41x40</td><td>HS1615C</td></tr> <tr><td><input type="checkbox"/> 40,5 x 42,5</td><td>41x43</td><td>HS1616C</td></tr> <tr><td><input type="checkbox"/> 40,5 x 45</td><td>41x45</td><td>HS1617C</td></tr> <tr><td><input type="checkbox"/> 40,5 x 47,5</td><td>41x48</td><td>HS1618C</td></tr> <tr><td><input type="checkbox"/> 40,5 x 52,5</td><td>41x53</td><td>HS1620C</td></tr> <tr><td><input type="checkbox"/> 43 x 42,5</td><td>43x43</td><td>HS1716C</td></tr> </tbody> </table>	Misure cuscino LxP	Adatto a seduta LxSxPS	Codice	<input type="checkbox"/> 35,5 x 37,5	36x38	HS1414C	<input type="checkbox"/> 35,5 x 42,5	36x43	HS1416C	<input type="checkbox"/> 38 x 40	38x40	HS1515C	<input type="checkbox"/> 38 x 42,5	38x43	HS1516C	<input type="checkbox"/> 38 x 45	38x45	HS1517C	<input type="checkbox"/> 40,5 x 40	41x40	HS1615C	<input type="checkbox"/> 40,5 x 42,5	41x43	HS1616C	<input type="checkbox"/> 40,5 x 45	41x45	HS1617C	<input type="checkbox"/> 40,5 x 47,5	41x48	HS1618C	<input type="checkbox"/> 40,5 x 52,5	41x53	HS1620C	<input type="checkbox"/> 43 x 42,5	43x43	HS1716C	<table border="1"> <thead> <tr> <th>Misure cuscino LxP</th> <th>Adatto a seduta LxSxPS</th> <th>Codice</th> </tr> </thead> <tbody> <tr><td><input type="checkbox"/> 43 x 45</td><td>43x45</td><td>HS1717C</td></tr> <tr><td><input type="checkbox"/> 43 x 47,5</td><td>43x48</td><td>HS1718C</td></tr> <tr><td><input type="checkbox"/> 43 x 52,5</td><td>43x53</td><td>HS1720C</td></tr> <tr><td><input type="checkbox"/> 45,5 x 42,5</td><td>46x43</td><td>HS1816C</td></tr> <tr><td><input type="checkbox"/> 45,5 x 45</td><td>46x45</td><td>HS1817C</td></tr> <tr><td><input type="checkbox"/> 45,5 x 47,5</td><td>46x48</td><td>HS1818C</td></tr> <tr><td><input type="checkbox"/> 45,5 x 52,5</td><td>46x53</td><td>HS1820C</td></tr> <tr><td><input type="checkbox"/> 51 x 42,5</td><td>51x43</td><td>HS2016C</td></tr> <tr><td><input type="checkbox"/> 51 x 45</td><td>51x45</td><td>HS2017C</td></tr> <tr><td><input type="checkbox"/> 51 x 47,5</td><td>51x48</td><td>HS2018C</td></tr> <tr><td><input type="checkbox"/> 51 x 52,5</td><td>51x53</td><td>HS2020C</td></tr> </tbody> </table>	Misure cuscino LxP	Adatto a seduta LxSxPS	Codice	<input type="checkbox"/> 43 x 45	43x45	HS1717C	<input type="checkbox"/> 43 x 47,5	43x48	HS1718C	<input type="checkbox"/> 43 x 52,5	43x53	HS1720C	<input type="checkbox"/> 45,5 x 42,5	46x43	HS1816C	<input type="checkbox"/> 45,5 x 45	46x45	HS1817C	<input type="checkbox"/> 45,5 x 47,5	46x48	HS1818C	<input type="checkbox"/> 45,5 x 52,5	46x53	HS1820C	<input type="checkbox"/> 51 x 42,5	51x43	HS2016C	<input type="checkbox"/> 51 x 45	51x45	HS2017C	<input type="checkbox"/> 51 x 47,5	51x48	HS2018C	<input type="checkbox"/> 51 x 52,5	51x53	HS2020C		
Misure cuscino LxP	Adatto a seduta LxSxPS	Codice																																																																									
<input type="checkbox"/> 35,5 x 37,5	36x38	HS1414C																																																																									
<input type="checkbox"/> 35,5 x 42,5	36x43	HS1416C																																																																									
<input type="checkbox"/> 38 x 40	38x40	HS1515C																																																																									
<input type="checkbox"/> 38 x 42,5	38x43	HS1516C																																																																									
<input type="checkbox"/> 38 x 45	38x45	HS1517C																																																																									
<input type="checkbox"/> 40,5 x 40	41x40	HS1615C																																																																									
<input type="checkbox"/> 40,5 x 42,5	41x43	HS1616C																																																																									
<input type="checkbox"/> 40,5 x 45	41x45	HS1617C																																																																									
<input type="checkbox"/> 40,5 x 47,5	41x48	HS1618C																																																																									
<input type="checkbox"/> 40,5 x 52,5	41x53	HS1620C																																																																									
<input type="checkbox"/> 43 x 42,5	43x43	HS1716C																																																																									
Misure cuscino LxP	Adatto a seduta LxSxPS	Codice																																																																									
<input type="checkbox"/> 43 x 45	43x45	HS1717C																																																																									
<input type="checkbox"/> 43 x 47,5	43x48	HS1718C																																																																									
<input type="checkbox"/> 43 x 52,5	43x53	HS1720C																																																																									
<input type="checkbox"/> 45,5 x 42,5	46x43	HS1816C																																																																									
<input type="checkbox"/> 45,5 x 45	46x45	HS1817C																																																																									
<input type="checkbox"/> 45,5 x 47,5	46x48	HS1818C																																																																									
<input type="checkbox"/> 45,5 x 52,5	46x53	HS1820C																																																																									
<input type="checkbox"/> 51 x 42,5	51x43	HS2016C																																																																									
<input type="checkbox"/> 51 x 45	51x45	HS2017C																																																																									
<input type="checkbox"/> 51 x 47,5	51x48	HS2018C																																																																									
<input type="checkbox"/> 51 x 52,5	51x53	HS2020C																																																																									
<b>ROHO® MONOCOMPARTIMENT® High Profile® altezza 10 cm</b> <span style="float: right;"><b>370,00</b></span>																																																																											
<table border="1"> <thead> <tr> <th>Misure cuscino LxP</th> <th>Adatto a seduta LxSxPS</th> <th>Codice</th> </tr> </thead> <tbody> <tr><td><input type="checkbox"/> 30 x 30 - (6 x 6)</td><td>26,5+31 x 26,5+31</td><td>1R66C</td></tr> <tr><td><input type="checkbox"/> 30 x 33 - (6 x 7)</td><td>26,5+31 x 31+35</td><td>1R67C</td></tr> <tr><td><input type="checkbox"/> 33 x 33 - (7 x 7)</td><td>31+35 x 31+35</td><td>1R77C</td></tr> <tr><td><input type="checkbox"/> 33 x 38 - (7 x 8)</td><td>31+35 x 35+39,5</td><td>1R78C</td></tr> <tr><td><input type="checkbox"/> 33 x 42 - (7 x 9)</td><td>31+35 x 39,5+44</td><td>1R79C</td></tr> <tr><td><input type="checkbox"/> 38 x 33 - (8 x 7)</td><td>35+39,5 x 31+35</td><td>1R87C</td></tr> <tr><td><input type="checkbox"/> 38 x 38 - (8 x 8)</td><td>35+39,5 x 35+39,5</td><td>1R88C</td></tr> <tr><td><input type="checkbox"/> 38 x 42 - (8 x 9)</td><td>35+39,5 x 39,5+44</td><td>1R89C</td></tr> <tr><td><input type="checkbox"/> 38 x 46 - (8 x 10)</td><td>35+39,5 x 44+48,5</td><td>1R810C</td></tr> <tr><td><input type="checkbox"/> 42 x 38 - (9 x 8)</td><td>39,5+44 x 35+39,5</td><td>1R98C</td></tr> <tr><td><input type="checkbox"/> 42 x 42 - (9 x 9)</td><td>39,5+44 x 39,5+44</td><td>1R99C</td></tr> </tbody> </table>	Misure cuscino LxP	Adatto a seduta LxSxPS	Codice	<input type="checkbox"/> 30 x 30 - (6 x 6)	26,5+31 x 26,5+31	1R66C	<input type="checkbox"/> 30 x 33 - (6 x 7)	26,5+31 x 31+35	1R67C	<input type="checkbox"/> 33 x 33 - (7 x 7)	31+35 x 31+35	1R77C	<input type="checkbox"/> 33 x 38 - (7 x 8)	31+35 x 35+39,5	1R78C	<input type="checkbox"/> 33 x 42 - (7 x 9)	31+35 x 39,5+44	1R79C	<input type="checkbox"/> 38 x 33 - (8 x 7)	35+39,5 x 31+35	1R87C	<input type="checkbox"/> 38 x 38 - (8 x 8)	35+39,5 x 35+39,5	1R88C	<input type="checkbox"/> 38 x 42 - (8 x 9)	35+39,5 x 39,5+44	1R89C	<input type="checkbox"/> 38 x 46 - (8 x 10)	35+39,5 x 44+48,5	1R810C	<input type="checkbox"/> 42 x 38 - (9 x 8)	39,5+44 x 35+39,5	1R98C	<input type="checkbox"/> 42 x 42 - (9 x 9)	39,5+44 x 39,5+44	1R99C	<table border="1"> <thead> <tr> <th>Misure cuscino LxP</th> <th>Adatto a seduta LxSxPS</th> <th>Codice</th> </tr> </thead> <tbody> <tr><td><input type="checkbox"/> 42 x 46 - (9 x 10)</td><td>39,5+44 x 44+48,5</td><td>1R910C</td></tr> <tr><td><input type="checkbox"/> 42 x 51 - (9 x 11)</td><td>39,5+44 x 48,5+52,5</td><td>1R911C</td></tr> <tr><td><input type="checkbox"/> 46 x 38 - (10 x 8)</td><td>44+48,5 x 35+39,5</td><td>1R108C</td></tr> <tr><td><input type="checkbox"/> 46 x 42 - (10 x 9)</td><td>44+48,5 x 39,5+44</td><td>1R109C</td></tr> <tr><td><input type="checkbox"/> 46 x 46 - (10 x 10)</td><td>44+48,5 x 44+48,5</td><td>1R1010C</td></tr> <tr><td><input type="checkbox"/> 46 x 51 - (10 x 11)</td><td>44+48,5 x 48,5+52,5</td><td>1R1011C</td></tr> <tr><td><input type="checkbox"/> 46 x 56 - (10 x 12)</td><td>44+48,5 x 52,5+57</td><td>1R1012C</td></tr> <tr><td><input type="checkbox"/> 51 x 42 - (11 x 9)</td><td>48,5+52,5 x 39,5+44</td><td>1R119C</td></tr> <tr><td><input type="checkbox"/> 51 x 46 - (11 x 10)</td><td>48,5+52,5 x 44+48,5</td><td>1R1110C</td></tr> <tr><td><input type="checkbox"/> 51 x 51 - (11 x 11)</td><td>48,5+52,5 x 48,5+52,5</td><td>1R1111C</td></tr> <tr><td><input type="checkbox"/> 51 x 56 - (11 x 12)</td><td>48,5+52,5 x 52,5+57</td><td>1R1112C</td></tr> </tbody> </table>	Misure cuscino LxP	Adatto a seduta LxSxPS	Codice	<input type="checkbox"/> 42 x 46 - (9 x 10)	39,5+44 x 44+48,5	1R910C	<input type="checkbox"/> 42 x 51 - (9 x 11)	39,5+44 x 48,5+52,5	1R911C	<input type="checkbox"/> 46 x 38 - (10 x 8)	44+48,5 x 35+39,5	1R108C	<input type="checkbox"/> 46 x 42 - (10 x 9)	44+48,5 x 39,5+44	1R109C	<input type="checkbox"/> 46 x 46 - (10 x 10)	44+48,5 x 44+48,5	1R1010C	<input type="checkbox"/> 46 x 51 - (10 x 11)	44+48,5 x 48,5+52,5	1R1011C	<input type="checkbox"/> 46 x 56 - (10 x 12)	44+48,5 x 52,5+57	1R1012C	<input type="checkbox"/> 51 x 42 - (11 x 9)	48,5+52,5 x 39,5+44	1R119C	<input type="checkbox"/> 51 x 46 - (11 x 10)	48,5+52,5 x 44+48,5	1R1110C	<input type="checkbox"/> 51 x 51 - (11 x 11)	48,5+52,5 x 48,5+52,5	1R1111C	<input type="checkbox"/> 51 x 56 - (11 x 12)	48,5+52,5 x 52,5+57	1R1112C		
Misure cuscino LxP	Adatto a seduta LxSxPS	Codice																																																																									
<input type="checkbox"/> 30 x 30 - (6 x 6)	26,5+31 x 26,5+31	1R66C																																																																									
<input type="checkbox"/> 30 x 33 - (6 x 7)	26,5+31 x 31+35	1R67C																																																																									
<input type="checkbox"/> 33 x 33 - (7 x 7)	31+35 x 31+35	1R77C																																																																									
<input type="checkbox"/> 33 x 38 - (7 x 8)	31+35 x 35+39,5	1R78C																																																																									
<input type="checkbox"/> 33 x 42 - (7 x 9)	31+35 x 39,5+44	1R79C																																																																									
<input type="checkbox"/> 38 x 33 - (8 x 7)	35+39,5 x 31+35	1R87C																																																																									
<input type="checkbox"/> 38 x 38 - (8 x 8)	35+39,5 x 35+39,5	1R88C																																																																									
<input type="checkbox"/> 38 x 42 - (8 x 9)	35+39,5 x 39,5+44	1R89C																																																																									
<input type="checkbox"/> 38 x 46 - (8 x 10)	35+39,5 x 44+48,5	1R810C																																																																									
<input type="checkbox"/> 42 x 38 - (9 x 8)	39,5+44 x 35+39,5	1R98C																																																																									
<input type="checkbox"/> 42 x 42 - (9 x 9)	39,5+44 x 39,5+44	1R99C																																																																									
Misure cuscino LxP	Adatto a seduta LxSxPS	Codice																																																																									
<input type="checkbox"/> 42 x 46 - (9 x 10)	39,5+44 x 44+48,5	1R910C																																																																									
<input type="checkbox"/> 42 x 51 - (9 x 11)	39,5+44 x 48,5+52,5	1R911C																																																																									
<input type="checkbox"/> 46 x 38 - (10 x 8)	44+48,5 x 35+39,5	1R108C																																																																									
<input type="checkbox"/> 46 x 42 - (10 x 9)	44+48,5 x 39,5+44	1R109C																																																																									
<input type="checkbox"/> 46 x 46 - (10 x 10)	44+48,5 x 44+48,5	1R1010C																																																																									
<input type="checkbox"/> 46 x 51 - (10 x 11)	44+48,5 x 48,5+52,5	1R1011C																																																																									
<input type="checkbox"/> 46 x 56 - (10 x 12)	44+48,5 x 52,5+57	1R1012C																																																																									
<input type="checkbox"/> 51 x 42 - (11 x 9)	48,5+52,5 x 39,5+44	1R119C																																																																									
<input type="checkbox"/> 51 x 46 - (11 x 10)	48,5+52,5 x 44+48,5	1R1110C																																																																									
<input type="checkbox"/> 51 x 51 - (11 x 11)	48,5+52,5 x 48,5+52,5	1R1111C																																																																									
<input type="checkbox"/> 51 x 56 - (11 x 12)	48,5+52,5 x 52,5+57	1R1112C																																																																									

Permobili Progeo Active Design s.r.l. - a Socio Unico - Vicolo L. Negrelli, 5 - 31038 Paese (TV) - Tel. +39 0422 484657  
 P. IVA, Codice Fiscale e Numero di iscrizione al Registro Imprese di Treviso 10246110968 - Fatturazione Elettronica: Codice Destinatario A4707H7 - Capitale Sociale I.V. € 10.000,00

Email: info\_fi@permobili.com - web: http://www.rehateamprogeo.com

Data \_\_\_\_\_ Commissa \_\_\_\_\_ Utilizzatore \_\_\_\_\_ Indirizzo \_\_\_\_\_

**O ROHO® MONOCOMPARTIMENT® Low Profile® altezza 5 cm** **370,00**

Misure cuscino LxP	Adatto a seduta LSxPS	Codice	Misure cuscino LxP	Adatto a seduta LSxPS	Codice
<input type="checkbox"/> 30 x 30 - (6 x 6)	26,5+31 x 26,5+31	<b>1R66LPC</b>	<input type="checkbox"/> 42 x 42 - (9 x 9)	39,5+44 x 39,5+44	<b>1R99LPC</b>
<input type="checkbox"/> 30 x 33 - (6 x 7)	26,5+31 x 31+35	<b>1R67LPC</b>	<input type="checkbox"/> 42 x 46 - (9 x 10)	39,5+44 x 44+48,5	<b>1R910LPC</b>
<input type="checkbox"/> 33 x 33 - (7 x 7)	31+35 x 31+35	<b>1R77LPC</b>	<input type="checkbox"/> 42 x 51 - (9 x 11)	39,5+44 x 48,5+52,5	<b>1R911LPC</b>
<input type="checkbox"/> 33 x 38 - (7 x 8)	31+35 x 35+39,5	<b>1R78LPC</b>	<input type="checkbox"/> 46 x 38 - (10 x 8)	44+48,5 x 35+39,5	<b>1R108LPC</b>
<input type="checkbox"/> 33 x 42 - (7 x 9)	31+35 x 39,5+44	<b>1R79LPC</b>	<input type="checkbox"/> 46 x 42 - (10 x 9)	44+48,5 x 39,5+44	<b>1R109LPC</b>
<input type="checkbox"/> 38 x 33 - (8 x 7)	35+39,5 x 31+35	<b>1R87LPC</b>	<input type="checkbox"/> 46 x 46 - (10 x 10)	44+48,5 x 44+48,5	<b>1R1010LPC</b>
<input type="checkbox"/> 38 x 38 - (8 x 8)	35+39,5 x 35+39,5	<b>1R88LPC</b>	<input type="checkbox"/> 46 x 51 - (10 x 11)	44+48,5 x 48,5+52,5	<b>1R1011LPC</b>
<input type="checkbox"/> 38 x 42 - (8 x 9)	35+39,5 x 39,5+44	<b>1R89LPC</b>	<input type="checkbox"/> 51 x 42 - (11 x 9)	48,5+52,5 x 39,5+44	<b>1R119LPC</b>
<input type="checkbox"/> 38 x 46 - (8 x 10)	35+39,5 x 44+48,5	<b>1R810LPC</b>	<input type="checkbox"/> 51 x 46 - (11 x 10)	48,5+52,5 x 44+48,5	<b>1R1110LPC</b>
<input type="checkbox"/> 42 x 38 - (9 x 8)	39,5+44 x 35+39,5	<b>1R98LPC</b>	<input type="checkbox"/> 51 x 51 - (11 x 11)	48,5+52,5 x 48,5+52,5	<b>1R1111LPC</b>



**O ROHO® QUADTRO SELECT® High Profile® altezza 10 cm** **630,00**

Misure cuscino LxP	Adatto a seduta LSxPS	Codice	Misure cuscino LxP	Adatto a seduta LSxPS	Codice
<input type="checkbox"/> 30 x 30 - (6 x 6)	26,5+31 x 26,5+31	<b>QS66C</b>	<input type="checkbox"/> 42 x 46 - (9 x 10)	39,5+44 x 44+48,5	<b>QS910C</b>
<input type="checkbox"/> 30 x 33 - (6 x 7)	26,5+31 x 31+35	<b>QS67C</b>	<input type="checkbox"/> 42 x 51 - (9 x 11)	39,5+44 x 48,5+52,5	<b>QS911C</b>
<input type="checkbox"/> 33 x 33 - (7 x 7)	31+35 x 31+35	<b>QS77C</b>	<input type="checkbox"/> 42 x 56 - (9 x 12)	39,5+44 x 52,5+57	<b>QS912C</b>
<input type="checkbox"/> 33 x 38 - (7 x 8)	31+35 x 35+39,5	<b>QS78C</b>	<input type="checkbox"/> 46 x 38 - (10 x 8)	44+48,5 x 35+39,5	<b>QS108C</b>
<input type="checkbox"/> 33 x 42 - (7 x 9)	31+35 x 39,5+44	<b>QS79C</b>	<input type="checkbox"/> 46 x 42 - (10 x 9)	44+48,5 x 39,5+44	<b>QS109C</b>
<input type="checkbox"/> 38 x 33 - (8 x 7)	35+39,5 x 31+35	<b>QS87C</b>	<input type="checkbox"/> 46 x 46 - (10 x 10)	44+48,5 x 44+48,5	<b>QS1010C</b>
<input type="checkbox"/> 38 x 38 - (8 x 8)	35+39,5 x 35+39,5	<b>QS88C</b>	<input type="checkbox"/> 46 x 51 - (10 x 11)	44+48,5 x 48,5+52,5	<b>QS1011C</b>
<input type="checkbox"/> 38 x 42 - (8 x 9)	35+39,5 x 39,5+44	<b>QS89C</b>	<input type="checkbox"/> 46 x 56 - (10 x 12)	44+48,5 x 52,5+57	<b>QS1012C</b>
<input type="checkbox"/> 38 x 46 - (8 x 10)	35+39,5 x 44+48,5	<b>QS810C</b>	<input type="checkbox"/> 51 x 42 - (11 x 9)	48,5+52,5 x 39,5+44	<b>QS119C</b>
<input type="checkbox"/> 42 x 38 - (9 x 8)	39,5+44 x 35+39,5	<b>QS98C</b>	<input type="checkbox"/> 51 x 46 - (11 x 10)	48,5+52,5 x 44+48,5	<b>QS1110C</b>
<input type="checkbox"/> 42 x 42 - (9 x 9)	39,5+44 x 39,5+44	<b>QS99C</b>	<input type="checkbox"/> 51 x 51 - (11 x 11)	48,5+52,5 x 48,5+52,5	<b>QS1111C</b>



**O ROHO® QUADTRO SELECT® Low Profile® altezza 5 cm** **630,00**

Misure cuscino LxP	Adatto a seduta LSxPS	Codice	Misure cuscino LxP	Adatto a seduta LSxPS	Codice
<input type="checkbox"/> 28 x 30 - (5 x 6)	22+26,5 x 26,5+31	<b>QS56LPC</b>	<input type="checkbox"/> 42 x 42 - (9 x 9)	39,5+44 x 39,5+44	<b>QS99LPC</b>
<input type="checkbox"/> 30 x 30 - (6 x 6)	26,5+31 x 26,5+31	<b>QS66LPC</b>	<input type="checkbox"/> 42 x 46 - (9 x 10)	39,5+44 x 44+48,5	<b>QS910LPC</b>
<input type="checkbox"/> 30 x 33 - (6 x 7)	26,5+31 x 31+35	<b>QS67LPC</b>	<input type="checkbox"/> 42 x 51 - (9 x 11)	39,5+44 x 48,5+52,5	<b>QS911LPC</b>
<input type="checkbox"/> 33 x 33 - (7 x 7)	31+35 x 31+35	<b>QS77LPC</b>	<input type="checkbox"/> 46 x 38 - (10 x 8)	44+48,5 x 35+39,5	<b>QS108LPC</b>
<input type="checkbox"/> 33 x 38 - (7 x 8)	31+35 x 35+39,5	<b>QS78LPC</b>	<input type="checkbox"/> 46 x 42 - (10 x 9)	44+48,5 x 39,5+44	<b>QS109LPC</b>
<input type="checkbox"/> 33 x 42 - (7 x 9)	31+35 x 39,5+44	<b>QS79LPC</b>	<input type="checkbox"/> 46 x 46 - (10 x 10)	44+48,5 x 44+48,5	<b>QS1010LPC</b>
<input type="checkbox"/> 38 x 33 - (8 x 7)	35+39,5 x 31+35	<b>QS87LPC</b>	<input type="checkbox"/> 46 x 51 - (10 x 11)	44+48,5 x 48,5+52,5	<b>QS1011LPC</b>
<input type="checkbox"/> 38 x 38 - (8 x 8)	35+39,5 x 35+39,5	<b>QS88LPC</b>	<input type="checkbox"/> 51 x 42 - (11 x 9)	48,5+52,5 x 39,5+44	<b>QS119LPC</b>
<input type="checkbox"/> 38 x 42 - (8 x 9)	35+39,5 x 39,5+44	<b>QS89LPC</b>	<input type="checkbox"/> 51 x 46 - (11 x 10)	48,5+52,5 x 44+48,5	<b>QS1110LPC</b>
<input type="checkbox"/> 38 x 46 - (8 x 10)	35+39,5 x 44+48,5	<b>QS810LPC</b>	<input type="checkbox"/> 51 x 51 - (11 x 11)	48,5+52,5 x 48,5+52,5	<b>QS1111LPC</b>
<input type="checkbox"/> 42 x 38 - (9 x 8)	39,5+44 x 35+39,5	<b>QS98LPC</b>			



**O ROHO® CONTOUR SELECT®** **630,00**

Misure cuscino LxP	Adatto a seduta LSxPS	Codice	Misure cuscino LxP	Adatto a seduta LSxPS	Codice
<input type="checkbox"/> 33 x 38 - (7 x 8)	31+35 x 35+39,5	<b>CS78C</b>	<input type="checkbox"/> 42 x 51 - (9 x 11)	39,5+44 x 48,5+52,5	<b>CS911C</b>
<input type="checkbox"/> 38 x 38 - (8 x 8)	35+39,5 x 35+39,5	<b>CS88C</b>	<input type="checkbox"/> 46 x 42 - (10 x 9)	44+48,5 x 39,5+44	<b>CS109C</b>
<input type="checkbox"/> 38 x 42 - (8 x 9)	35+39,5 x 39,5+44	<b>CS89C</b>	<input type="checkbox"/> 46 x 46 - (10 x 10)	44+48,5 x 44+48,5	<b>CS1010C</b>
<input type="checkbox"/> 38 x 46 - (8 x 10)	35+39,5 x 44+48,5	<b>CS810C</b>	<input type="checkbox"/> 46 x 51 - (10 x 11)	44+48,5 x 48,5+52,5	<b>CS1011C</b>
<input type="checkbox"/> 42 x 38 - (9 x 8)	39,5+44 x 35+39,5	<b>CS98C</b>	<input type="checkbox"/> 51 x 42 - (11 x 9)	48,5+52,5 x 39,5+44	<b>CS119C</b>
<input type="checkbox"/> 42 x 42 - (9 x 9)	39,5+44 x 39,5+44	<b>CS99C</b>	<input type="checkbox"/> 51 x 46 - (11 x 10)	48,5+52,5 x 44+48,5	<b>CS1110C</b>
<input type="checkbox"/> 42 x 46 - (9 x 10)	39,5+44 x 44+48,5	<b>CS910C</b>	<input type="checkbox"/> 51 x 51 - (11 x 11)	48,5+52,5 x 48,5+52,5	<b>CS1111C</b>



**O ROHO® ENHANCER®** **630,00**

Misure cuscino LxP	Adatto a seduta LSxPS	Codice	Misure cuscino LxP	Adatto a seduta LSxPS	Codice
<input type="checkbox"/> 38 x 38 - (8 x 8)	35+39,5 x 35+39,5	<b>ENH88C</b>	<input type="checkbox"/> 46 x 42 - (10 x 9)	44+48,5 x 39,5+44	<b>ENH109C</b>
<input type="checkbox"/> 38 x 42 - (8 x 9)	35+39,5 x 39,5+44	<b>ENH89C</b>	<input type="checkbox"/> 46 x 46 - (10 x 10)	44+48,5 x 44+48,5	<b>ENH1010C</b>
<input type="checkbox"/> 42 x 38 - (9 x 8)	39,5+44 x 35+39,5	<b>ENH98C</b>	<input type="checkbox"/> 46 x 51 - (10 x 11)	44+48,5 x 48,5+52,5	<b>ENH1011C</b>
<input type="checkbox"/> 42 x 42 - (9 x 9)	39,5+44 x 39,5+44	<b>ENH99C</b>	<input type="checkbox"/> 51 x 46 - (11 x 10)	48,5+52,5 x 44+48,5	<b>ENH1110C</b>
<input type="checkbox"/> 42 x 46 - (9 x 10)	39,5+44 x 44+48,5	<b>ENH910C</b>			



Carrozzina : Progeo EASY TILT SMART - Rev. 2026.0

Prezzo IVA esclusa  
da sommare al prezzo di listino

Pagina da inviare se sono stati scelti optional

**standard** (fornito in assenza di altre indicazioni)

**su richiesta** (senza aggiunta di prezzo)

**optional** (sommare il prezzo a quello di listino)

Stampato il

Permobil Progeo Active Design s.r.l. - a Socio Unico - Vicolo L. Negrèlli, 5 - 31038 Paese (TV) - Tel. +39 0422 484657  
 P.IVA, Codice Fiscale e Numero di iscrizione al Registro Imprese di Treviso 10246110968 - Fatturatore Elettronico: Codice Destinatario A4707H7 - Capitale Sociale I.V. € 10.000,00

Email: info\_fi@permobil.com - web: http://www.rehateamprogeo.com

Data ..... Commessa ..... Utilizzatore ..... Indirizzo .....

## SMARTDRIVE - compreso di caricabatteria



 <b>SWITCH CONTROL (DX+SX) - EU</b> Funzionamento a due pulsanti	<input type="radio"/> 6 KM/H	MX2-S002	4.000,00
	<input type="radio"/> 9 KM/H	MX2-S005	4.100,00

 <b>SWITCH CONTROL + JACK 3.5 - EU</b> Un pulsante e un ingresso femmina Mono che permette di collegare SmartDrive con un qualsiasi altro dispositivo di comando/guida.	<input type="radio"/> 6 KM/H	MX2-S003	4.000,00
	<input type="radio"/> 9 KM/H	MX2-S006	4.100,00

**Pulsante di comando esterno BUDDY BUTTON**  
 completo di adattatore, set di montaggio e braccio di estensione  
*Disponibile solo con SWITCH CONTROL + JACK 3.5*



MX2-BBB 250,00

### KIT FISSAGGIO TELAIO RIGIDO

Scegliere kit di fissaggio in funzione della misura delle ruote posteriori della carrozzina

- kit fissaggio telaio rigido - ruote posteriori 22" - 24" MX2-44S-C
- kit fissaggio telaio rigido - ruote posteriori 25" MX2-45S-C
- kit fissaggio telaio rigido - ruote posteriori 26" MX2-46S-C

## SMART WATCH

Lo SmartDrive può essere comandato e gestito con uno Smart Watch APPLE o GALAXY  
 Configurazione semplice e veloce  
 Maggiore visibilità dello schermo  
 Prestazioni della batteria migliorate  
 App gratuita su Apple Store e Play Store

### Lista compatibilità'



### Smart Watch compatibili

**APPLE WATCH**  
 serie 5 o successivi con iOS 8 o successivi  
 Apple iPhone

**GALAXY WATCH**  
 serie 4 o successivi  
 Smartphone Samsung  
 Smartphone Android 6.0 e RAM almeno 1.5 GB

### Applicazioni gratuite

SmartDrive MX2+



Pushtracker



## Accessori

Borsa da trasporto



MX2SD-BAG 60,00

Maniglia universale imbottita  
*Maniglia universale imbottita*



MX2-986 20,00

Carrozzina : Progeo EASY TILT SMART - Rev. 2026.0

Prezzo IVA esclusa  
 da sommare al prezzo di listino

### Pagina da inviare se sono stati scelti optional

- standard** (fornito in assenza di altre indicazioni)
- su richiesta** (senza aggiunta di prezzo)
- optional** (sommare il prezzo a quello di listino)