

Data	Italia Timbro ditta	Carrozzina superleggera rigida Riconducibile N.T. Cod. 12.21.06.060 CRASH TEST APPROVED
Utilizzatore		
Peso utilizzatore (kg)		
Lingua manuale d'uso	Responsabile	

Misure carrozzina - La tolleranza su tutte le dimensioni indicate e/o richieste è di ± 10 mm

Larghezza sedile (LS) 24 27 30 33 36
 La larghezza della seduta è misurata all'esterno dei tubi telaio, mentre la distanza interna tra le due spondine risulta più larga di circa 1 cm.

Profondità sedile (PS) 27,5 30 32,5 35 37,5 40
 La profondità della seduta può essere aumentata successivamente di 2,5 o 5 cm.

Distanza pedana (DP) min 8 - max 39,5 (cm) $\pm 0,5$ cm - step di regolazione 1,5cm
(Distanza tela sedile - piatto pedana) - ATTENZIONE! Altezza anteriore minimo 4 cm maggiore della DISTANZA PEDANA

Assetto Standard Prudente Attivo

Altezza schienale (TS) Val.Standard 33,5(min 30,5 - max 51) step di regolazione 1,5cm

campanatura 0° 2° 4°

ALTEZZA ANTERIORE (STD 45)	ALTEZZA POSTERIORE (STD 41)
Ruote anteriori 3" (min 35 - max 51)	Ruote posteriori 22" (min 35 - max 45)
Ruote anteriori 4" (min 35 - max 52)	Ruote posteriori 24" (min 37 - max 47)
Ruote anteriori 5" (min 35 - max 53)	

La differenza tra Altezza Anteriore e Distanza pedana deve essere maggiore di 10cm

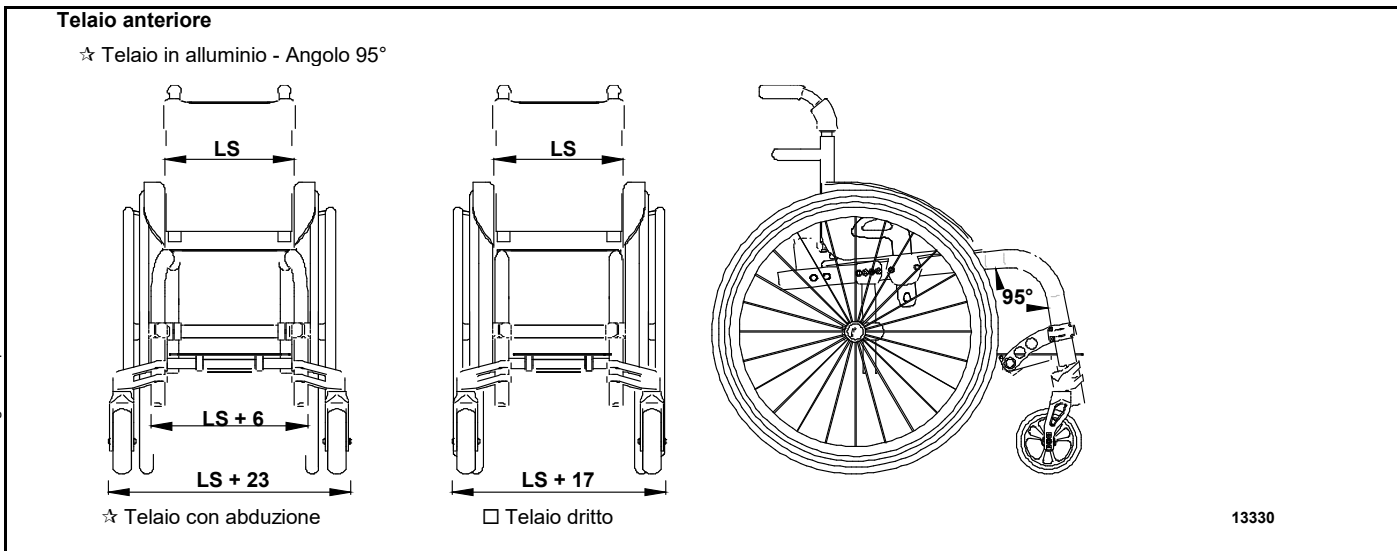

Colore telaio

Colore telaio (senza aggiunta di prezzo)

☆ Nero opaco □ Bianco POLAR □ Arancio Opaco
 □ Tekno antracite □ Blu notte opaco □ Grigio opaco □ Rosso opaco

Colore telaio su richiesta

○ Argento brillante ○ Fucsia brillante ○ Rosso brillante **12579 120,00**
 ○ Azzurro brillante ○ Lime brillante

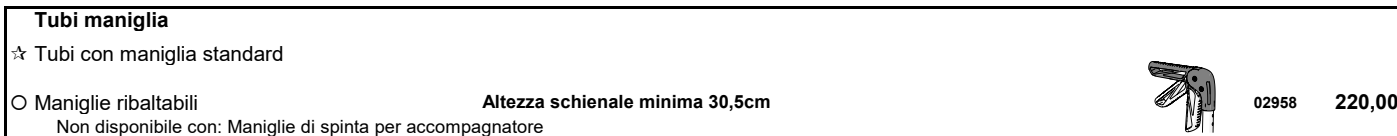
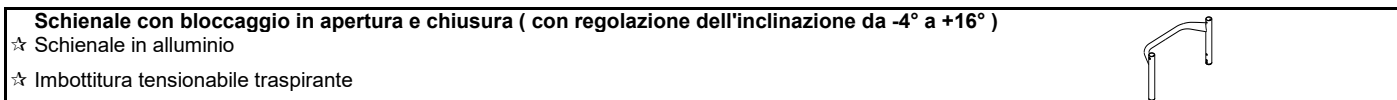
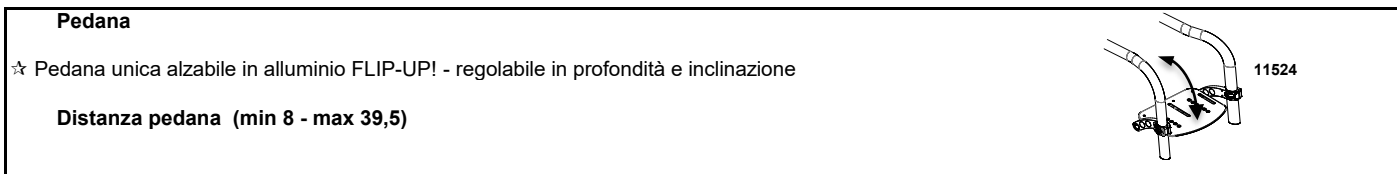

Permobili Progeo Active Design s.r.l. - a Socio Unico - Vicoletto L. Negrelli, 5 - 31038 Paese (TV) - Tel. +39 0422 484657
 P.IVA, Codice Fiscale e Numero di iscrizione al Registro Imprese di Treviso 10246110968 - Fatturazione Elettronica: Codice Destinatario A4707H7 - Capitale Sociale I.V. € 10.000,00

Email: info_it@permobil.com - web: http://www.rehaleamprogeo.com

Data Compressa Utilizzatore Indirizzo

Colore forcella

- ☆ Nero opaco
 - Argento brillante
 - Bianco POLAR
 - Rosso brillante
 - Tekno antracite
 - Grigio opaco
- Azzurro brillante
- Fucsia brillante
- Lime brillante
- Blu notte opaco
- Rosso opaco

08342 70,00

Colore ruote posteriori

Abbinabile solo con: Ruote posteriori Superleggera Standard Progeo (22 - 24)

- ☆ Nero
 - Argento brillante
 - Bianco POLAR
 - Rosso brillante
 - Tekno antracite
 - Grigio opaco
- Azzurro brillante
- Fucsia brillante
- Lime brillante
- Blu notte opaco
- Rosso opaco

04692 70,00

Ruote anteriori

- ☆ 4" Piena Soft
- 3" Sport *Configurazione più leggera*
- 5" Piena Soft
- 3" Active Soft (larga) (Cerchio in lega di alluminio) 06824 **120,00**
- 4" Active Sport (stretta) (Cerchio in lega di alluminio) 01398 **120,00**
- 4" Active Soft (larga) (Cerchio in lega di alluminio) 03943 **120,00**
- 5" Active Soft (larga) (Cerchio in lega di alluminio) 07518 **120,00**
- 5" Pneumatica 10844 **60,00**

Ruote posteriori

- ☆ 24" Superleggera Standard Progeo
- 22" Superleggera Standard Progeo
- 24" ULTRALEGGERA PROGEO KEY SPORT *Configurazione più leggera* 04383 **750,00**
- 24" Superleggera "Spinergy LX" 01685 **750,00**
- 24" Superleggera "Spinergy LXL" Raggi bianchi e mozzo nero Raggi e mozzo neri 07846 **750,00**
- 24" Superleggera "Spinergy Flex rim" Corrimano incorporato Alluminio/Gomma 02270 **1.200,00**
- 24" Fuoristrada (corrimano in alluminio nero - Distanza ruota 4cm) 01392 **250,00**

Copertura ruota posteriore

- ☆ Liscio Alta Pressione (22"-24") *Configurazione più leggera*
 - Tassellato Alta Pressione (24")
 - Marathon Plus (24") con protezione anti foratura 01669 **90,00**
 - Copertura piena - Colore Grigio (22") 04181 **110,00**
 - Copertura piena - Colore Nero (24") 11083 **110,00**
- Non disponibile con Ruote posteriori: 24" ULTRALEGGERA PROGEO KEY SPORT, 24" Superleggera "Spinergy LXL"**

Cerchi di spinta

Distanza ruota ☆ 3 cm 4 cm

- ☆ Alluminio (22"-24") *Configurazione più leggera*
- Alluminio Nero SOFT-TOUCH (24") 09170 **110,00**
- Acciaio cromato (24") 01684 **170,00**
- Titanio (24") 00016 **270,00**
- Ultra Grepp (24") 00017 **300,00**
- TOP FRICTION (24") 11023 **290,00**
Profilo ovale con inserto in gomma
- NOVA H (24") 11025 **270,00**
Profilo ergonomico colore nero
- NOVA D (24") 11026 **290,00**
Profilo ergonomico con rivestimento in gomma (ideale per tetraplegici)
- Anello anti scivolo in silicone applicabile su cerchio in alluminio Disponibile per misure da (22"-24") 04050 **170,00**

Freni

- ☆ Freno leva curva da spingere 
- Freno leva dritta da spingere 
- Freno leva dritta da tirare 
- Freno con leva prolungata da spingere 01949 **70,00**
- Freno con leva prolungata da tirare 03372 **70,00**

Data	Commessa	Utilizzatore	Indirizzo
------------	----------------	--------------------	-----------------

Protezione vestiario

- ☆ Parafango estraibile in ABS
 - Protezione estraibile dritta in ABS
 - Parafango estraibile in carbonio
 - Protezione estraibile dritta in Carbonio
- 

03946	290,00
03946	290,00

Braccioli

- Braccioli Tubolari (Girevoli estraibili regolabili in altezza)
- Altezza montaggio (Rispetto alla seduta): 27 28,5 30 31,5 33 34,5 36



04828 **190,00**

Braccioli estraibili CON protezione vestiario integrata

- Braccioli estraibili con protezione dritta in ABS
- Braccioli estraibili con protezione dritta in Carbonio



08881 **200,00**
08882 **390,00**

SAFETY

- Sistema di ancoraggio a 4 punti per fissaggio carrozzina (l'installazione deve essere eseguita dalla casa costruttrice).
Installare un appoggiatesta idoneo per il trasporto e posizionarlo sempre adeguatamente durante il trasporto.



08654 **190,00**

Accessori

- Imbottitura paracolpi telaio anteriore
- Patella di raccordo schienale/tela sedile
- Borsello portaoggetti removibile (con aggancio rapido)

07058 **50,00**
10241 **20,00**
09811 **120,00**

Optional 1

- Ruota antiribaltamento con aggancio rapido (rotazione all'interno per ridurre l'ingombro)
La prima viene fornita gratuitamente ☆ Destra Sinistra
- La seconda prevede il supplemento Destra Sinistra



06821 **130,00**
06822 **130,00**

Optional 2

- Maniglione unico di spinta per accompagnatore (Regolabili in altezza ed estraibili)
- Maniglie di spinta per accompagnatore (Regolabili in altezza ed estraibili)
- Tetraclip (perno estrazione rapida per tetraplegici)
- Cinghia pelvica di ancoraggio
- Cinghia di bretellaggio
- Supporto lombare (da inserire all'interno dello schienale)
- Spinta laterale (Non disponibile con Schienale posturale PHYSIO - Schienale posturale A I R)
Impedisce l'abbattimento dello schienale Destra Sinistra
- Copriraggi Nero (22"-24")
- Copriraggi Trasparente (22"-24")
- Copriraggi Colorato Progeo Design (22"-24")



08930 **190,00**
03645 **190,00**
03947 **170,00**
03972 **70,00**
04103 **130,00**
00013 **50,00**
02097 **250,00**
02098 **250,00**
01043 **160,00**
00835 **160,00**
00019 **180,00**

Kit aggiuntivo

- Ruote posteriori 24" Fuoristrada Copertone Fuoristrada - corrimano in alluminio (colore nero) 03378 **500,00**
- Ruote posteriori FAT 24" Copertone liscio FAT 3" - corrimano in alluminio (colore nero) 09357 **850,00**

Permobili Progeo Active Design s.r.l. - a Socio Unico - Vicolo L. Negrelli, 5 - 31038 Paese (TV) - Tel. +39 0422 484657
 P.IVA, Codice Fiscale e Numero di iscrizione al Registro Imprese di Treviso 10246110968 - Fatturazione Elettronica: Codice Destinatario A4707H7 - Capitale Sociale I.V. € 10.000,00

Email: info_it@permobili.com - web: http://www.rehateamprogeo.com

Data Comessa Utilizzatore Indirizzo

PHYSIO - Imbottitura schienale originale non fornita

Estraibile con aggancio rapido
 Installazione su tubi diametro 18÷26mm
 Regolazione in profondità (4cm)
 Regolazione inclinazione (±18°)

Schienale posturale VERSIONE KID BAMBINO

KID Guscio ALLUMINIO

ATTENZIONE con questo schienale si riduce la profondità della seduta di circa 5cm.

non disponibile per larghezza 24

ALTEZZA SCHIENALE	29	34	40
Conformazione del guscio 	Ala di contenimento laterale R=regolare		
	R	R	R

830,00

Schienale posturale VERSIONE ADULTO

AIR Guscio CARBONIO

non disponibile per larghezza 27 - 30

ALTEZZA SCHIENALE	28	34	40			
Conformazione del guscio 	Ala di contenimento laterale A=alta - R=regolare					
	A	R	A	R	A	R

860,00

POSTURE Guscio ALLUMINIO

non disponibile per larghezza 27 - 30

ALTEZZA SCHIENALE	34	40	52
Conformazione del guscio 	Ala di contenimento laterale R=regolare		
	R	R	R

830,00

Configurazione DEEP con PAD per contenimento laterale (regolabili in altezza)

Pad in alluminio con imbottitura e rivestimento in tessuto traspirante



Piccolo (h 13cm)



Destro 10272 40,00

Sinistro 10272 40,00

Grande (h 20cm)



Destro 10273 50,00

Sinistro 10273 50,00

Permobili Progeo Active Design s.r.l. - a Socio Unico - Vicolo L. Negrelli, 5 - 31038 Paese (TV) - Tel. +39 0422 484657
 P.IVA, Codice Fiscale e Numero di iscrizione al Registro Imprese di Treviso 10246110968 - Fatturazione Elettronica: Codice Destinatario A4707H7 - Capitale Sociale I.V. € 10.000,00

Email: info_it@permobili.com - web: http://www.rehateamprogeo.com

Data Comnessa Utilizzatore Indirizzo

Accessori

KID AIR POSTURE

Supporti toracici (spinta laterale) - SWING AWAY - Girevole
Non disponibile su schienale Physio AIR Guscio in Carbonio
Hardware di fissaggio e regolazione completi di imbottitura paracolpi
Pad in alluminio con imbottitura e rivestimento in tessuto traspirante

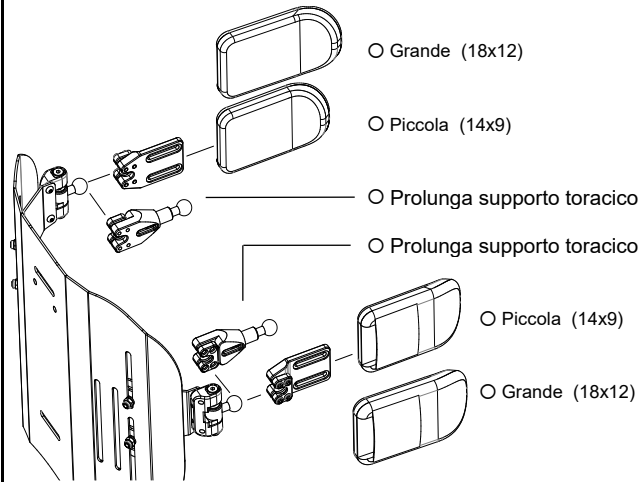

Grande (18x12) 05647 170,00

Piccola (14x9) 05643 170,00

Prolunga supporto toracico Quantità (n° pz)..... 10271 60,00

Prolunga supporto toracico Quantità (n° pz).....

Piccola (14x9) 05642 170,00

Grande (18x12) 05646 170,00

Poggiatesta multiregolazione - sistema di montaggio a doppia sfera
Disponibile solo su schienale Physio Posture e Kid

Grande (35x12,5) 05648 360,00
 Piccola (25x12,5)

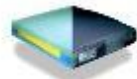

Cuscini antidecubito e posturali a nido d'ape STIMULITE

Classic H 7 cm. 36x41 00035 38x38 00036 38x41 01052  630,00

Anatomico Posturale H 9 cm.
H 5cm. nella zona ischiatica 36x41 00056 38x38 00696 38x41 00032  630,00

Slimline sagomato H 7 cm.
H 5cm. nella zona ischiatica 36x41 00854 38x38 00707 38x41 00083  630,00

Sport H 5 cm. 36x41 00053 38x38 00054 38x41 01060  630,00

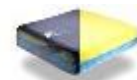
Corbee Pediatrico H 5 cm. 25x25 00052 30x30 00845 36x36 00079  630,00

Pediatrico anatomico posturale H 6 cm.
H 5cm. nella zona ischiatica 25x25 00638 30x30 01351 36x36 00639  630,00

Misura cliente Larghezza cm. Profondità cm.

Supporto lombare STIMULITE  00064 220,00







Pagina da inviare se sono stati scelti optional

<input checked="" type="checkbox"/>	standard	(fornito in assenza di altre indicazioni)
<input type="checkbox"/>	su richiesta	(senza aggiunta di prezzo)
<input type="checkbox"/>	optional	(sommare il prezzo a quello di listino)

Carrozzina : Progeo JOKER JUNIOR 2.0 - Rev. 2026.0

Prezzo IVA esclusa
da sommare al prezzo di listino

Permobili Progeo Active Design s.r.l. - a Socio Unico - Vicolo L. Negrelli, 5 - 31038 Paese (TV) - Tel. +39 0422 484657
 P.IVA, Codice Fiscale e Numero di iscrizione al Registro Imprese di Treviso 10246110968 - Fatturazione Elettronica: Codice Destinatario A4707H7 - Capitale Sociale I.V. € 10.000,00

Data	Commessa	Utilizzatore	Indirizzo																																																																							
ROHO® MOSAIC® - H7cm - Limite di peso 143Kg			200,00																																																																							
<table border="1" style="width: 100%; border-collapse: collapse;"> <thead> <tr> <th>Misure cuscino LxP</th> <th>Adatto a seduta LSxPS</th> <th>Codice</th> </tr> </thead> <tbody> <tr><td><input type="checkbox"/> 41 x 41</td><td>42 x 42</td><td>MOS1616HD</td></tr> <tr><td><input type="checkbox"/> 41 x 46</td><td>42 x 47</td><td>MOS1618HD</td></tr> <tr><td><input type="checkbox"/> 44 x 44</td><td>44 x 44</td><td>MOS1717HD</td></tr> </tbody> </table>	Misure cuscino LxP	Adatto a seduta LSxPS	Codice	<input type="checkbox"/> 41 x 41	42 x 42	MOS1616HD	<input type="checkbox"/> 41 x 46	42 x 47	MOS1618HD	<input type="checkbox"/> 44 x 44	44 x 44	MOS1717HD	<table border="1" style="width: 100%; border-collapse: collapse;"> <thead> <tr> <th>Misure cuscino LxP</th> <th>Adatto a seduta LSxPS</th> <th>Codice</th> </tr> </thead> <tbody> <tr><td><input type="checkbox"/> 46 x 41</td><td>47 x 42</td><td>MOS1816HD</td></tr> <tr><td><input type="checkbox"/> 46 x 46</td><td>47 x 47</td><td>MOS1818HD</td></tr> <tr><td><input type="checkbox"/> 51 x 46</td><td>52 x 47</td><td>MOS2018HD</td></tr> </tbody> </table>	Misure cuscino LxP	Adatto a seduta LSxPS	Codice	<input type="checkbox"/> 46 x 41	47 x 42	MOS1816HD	<input type="checkbox"/> 46 x 46	47 x 47	MOS1818HD	<input type="checkbox"/> 51 x 46	52 x 47	MOS2018HD																																																	
Misure cuscino LxP	Adatto a seduta LSxPS	Codice																																																																								
<input type="checkbox"/> 41 x 41	42 x 42	MOS1616HD																																																																								
<input type="checkbox"/> 41 x 46	42 x 47	MOS1618HD																																																																								
<input type="checkbox"/> 44 x 44	44 x 44	MOS1717HD																																																																								
Misure cuscino LxP	Adatto a seduta LSxPS	Codice																																																																								
<input type="checkbox"/> 46 x 41	47 x 42	MOS1816HD																																																																								
<input type="checkbox"/> 46 x 46	47 x 47	MOS1818HD																																																																								
<input type="checkbox"/> 51 x 46	52 x 47	MOS2018HD																																																																								
ROHO® AIR LITE® - H9,5cm - Limite di peso 136Kg			200,00																																																																							
<table border="1" style="width: 100%; border-collapse: collapse;"> <thead> <tr> <th>Misure cuscino LxP</th> <th>Codice</th> </tr> </thead> <tbody> <tr><td><input type="checkbox"/> 33 x 33</td><td>AL1313HD</td></tr> <tr><td><input type="checkbox"/> 33 x 38</td><td>AL1315HD</td></tr> <tr><td><input type="checkbox"/> 36 x 36</td><td>AL1414HD</td></tr> <tr><td><input type="checkbox"/> 36 x 41</td><td>AL1416HD</td></tr> <tr><td><input type="checkbox"/> 38 x 38</td><td>AL1515HD</td></tr> <tr><td><input type="checkbox"/> 38 x 43</td><td>AL1517HD</td></tr> <tr><td><input type="checkbox"/> 41 x 41</td><td>AL1616HD</td></tr> <tr><td><input type="checkbox"/> 41 x 46</td><td>AL1618HD</td></tr> <tr><td><input type="checkbox"/> 43 x 43</td><td>AL1717HD</td></tr> </tbody> </table>	Misure cuscino LxP	Codice	<input type="checkbox"/> 33 x 33	AL1313HD	<input type="checkbox"/> 33 x 38	AL1315HD	<input type="checkbox"/> 36 x 36	AL1414HD	<input type="checkbox"/> 36 x 41	AL1416HD	<input type="checkbox"/> 38 x 38	AL1515HD	<input type="checkbox"/> 38 x 43	AL1517HD	<input type="checkbox"/> 41 x 41	AL1616HD	<input type="checkbox"/> 41 x 46	AL1618HD	<input type="checkbox"/> 43 x 43	AL1717HD	<table border="1" style="width: 100%; border-collapse: collapse;"> <thead> <tr> <th>Misure cuscino LxP</th> <th>Codice</th> </tr> </thead> <tbody> <tr><td><input type="checkbox"/> 43 x 46</td><td>AL1718HD</td></tr> <tr><td><input type="checkbox"/> 43 x 51</td><td>AL1720HD</td></tr> <tr><td><input type="checkbox"/> 46 x 41</td><td>AL1816HD</td></tr> <tr><td><input type="checkbox"/> 46 x 46</td><td>AL1818HD</td></tr> <tr><td><input type="checkbox"/> 46 x 51</td><td>AL1820HD</td></tr> <tr><td><input type="checkbox"/> 48 x 43</td><td>AL1917HD</td></tr> <tr><td><input type="checkbox"/> 48 x 48</td><td>AL1919HD</td></tr> <tr><td><input type="checkbox"/> 51 x 43</td><td>AL2017HD</td></tr> <tr><td><input type="checkbox"/> 51 x 46</td><td>AL2018HD</td></tr> </tbody> </table>	Misure cuscino LxP	Codice	<input type="checkbox"/> 43 x 46	AL1718HD	<input type="checkbox"/> 43 x 51	AL1720HD	<input type="checkbox"/> 46 x 41	AL1816HD	<input type="checkbox"/> 46 x 46	AL1818HD	<input type="checkbox"/> 46 x 51	AL1820HD	<input type="checkbox"/> 48 x 43	AL1917HD	<input type="checkbox"/> 48 x 48	AL1919HD	<input type="checkbox"/> 51 x 43	AL2017HD	<input type="checkbox"/> 51 x 46	AL2018HD																																	
Misure cuscino LxP	Codice																																																																									
<input type="checkbox"/> 33 x 33	AL1313HD																																																																									
<input type="checkbox"/> 33 x 38	AL1315HD																																																																									
<input type="checkbox"/> 36 x 36	AL1414HD																																																																									
<input type="checkbox"/> 36 x 41	AL1416HD																																																																									
<input type="checkbox"/> 38 x 38	AL1515HD																																																																									
<input type="checkbox"/> 38 x 43	AL1517HD																																																																									
<input type="checkbox"/> 41 x 41	AL1616HD																																																																									
<input type="checkbox"/> 41 x 46	AL1618HD																																																																									
<input type="checkbox"/> 43 x 43	AL1717HD																																																																									
Misure cuscino LxP	Codice																																																																									
<input type="checkbox"/> 43 x 46	AL1718HD																																																																									
<input type="checkbox"/> 43 x 51	AL1720HD																																																																									
<input type="checkbox"/> 46 x 41	AL1816HD																																																																									
<input type="checkbox"/> 46 x 46	AL1818HD																																																																									
<input type="checkbox"/> 46 x 51	AL1820HD																																																																									
<input type="checkbox"/> 48 x 43	AL1917HD																																																																									
<input type="checkbox"/> 48 x 48	AL1919HD																																																																									
<input type="checkbox"/> 51 x 43	AL2017HD																																																																									
<input type="checkbox"/> 51 x 46	AL2018HD																																																																									
ROHO® HYBRID ELITE SR® - Monovalvola - Sensor Ready - Limite di peso 225Kg			630,00																																																																							
<table border="1" style="width: 100%; border-collapse: collapse;"> <thead> <tr> <th>Misure cuscino LxP</th> <th>Adatto a seduta LSxPS</th> <th>Codice</th> </tr> </thead> <tbody> <tr><td><input type="checkbox"/> 35 x 37,5</td><td>36 x 36</td><td>1RHE1414C-SR</td></tr> <tr><td><input type="checkbox"/> 35 x 40</td><td>36 x 38</td><td>1RHE1415C-SR</td></tr> <tr><td><input type="checkbox"/> 35 x 43</td><td>36 x 41</td><td>1RHE1416C-SR</td></tr> <tr><td><input type="checkbox"/> 37,5 x 40</td><td>38 x 38</td><td>1RHE1515C-SR</td></tr> <tr><td><input type="checkbox"/> 37,5 x 43</td><td>38 x 41</td><td>1RHE1516C-SR</td></tr> <tr><td><input type="checkbox"/> 37,5 x 45</td><td>38 x 43</td><td>1RHE1517C-SR</td></tr> <tr><td><input type="checkbox"/> 40 x 40</td><td>41 x 38</td><td>1RHE1615C-SR</td></tr> <tr><td><input type="checkbox"/> 40 x 43</td><td>41 x 41</td><td>1RHE1616C-SR</td></tr> <tr><td><input type="checkbox"/> 40 x 45</td><td>41 x 43</td><td>1RHE1617C-SR</td></tr> <tr><td><input type="checkbox"/> 40 x 48</td><td>41 x 46</td><td>1RHE1618C-SR</td></tr> <tr><td><input type="checkbox"/> 40 x 53</td><td>41 x 51</td><td>1RHE1620C-SR</td></tr> </tbody> </table>	Misure cuscino LxP	Adatto a seduta LSxPS	Codice	<input type="checkbox"/> 35 x 37,5	36 x 36	1RHE1414C-SR	<input type="checkbox"/> 35 x 40	36 x 38	1RHE1415C-SR	<input type="checkbox"/> 35 x 43	36 x 41	1RHE1416C-SR	<input type="checkbox"/> 37,5 x 40	38 x 38	1RHE1515C-SR	<input type="checkbox"/> 37,5 x 43	38 x 41	1RHE1516C-SR	<input type="checkbox"/> 37,5 x 45	38 x 43	1RHE1517C-SR	<input type="checkbox"/> 40 x 40	41 x 38	1RHE1615C-SR	<input type="checkbox"/> 40 x 43	41 x 41	1RHE1616C-SR	<input type="checkbox"/> 40 x 45	41 x 43	1RHE1617C-SR	<input type="checkbox"/> 40 x 48	41 x 46	1RHE1618C-SR	<input type="checkbox"/> 40 x 53	41 x 51	1RHE1620C-SR	<table border="1" style="width: 100%; border-collapse: collapse;"> <thead> <tr> <th>Misure cuscino LxP</th> <th>Adatto a seduta LSxPS</th> <th>Codice</th> </tr> </thead> <tbody> <tr><td><input type="checkbox"/> 43 x 43</td><td>43 x 41</td><td>1RHE1716C-SR</td></tr> <tr><td><input type="checkbox"/> 43 x 45</td><td>43 x 43</td><td>1RHE1717C-SR</td></tr> <tr><td><input type="checkbox"/> 43 x 48</td><td>43 x 46</td><td>1RHE1718C-SR</td></tr> <tr><td><input type="checkbox"/> 43 x 53</td><td>43 x 51</td><td>1RHE1720C-SR</td></tr> <tr><td><input type="checkbox"/> 45 x 43</td><td>46 x 41</td><td>1RHE1816C-SR</td></tr> <tr><td><input type="checkbox"/> 45 x 45</td><td>46 x 43</td><td>1RHE1817C-SR</td></tr> <tr><td><input type="checkbox"/> 45 x 48</td><td>46 x 46</td><td>1RHE1818C-SR</td></tr> <tr><td><input type="checkbox"/> 45 x 53</td><td>46 x 51</td><td>1RHE1820C-SR</td></tr> <tr><td><input type="checkbox"/> 50 x 45</td><td>51 x 43</td><td>1RHE2017C-SR</td></tr> <tr><td><input type="checkbox"/> 50 x 48</td><td>51 x 46</td><td>1RHE2018C-SR</td></tr> <tr><td><input type="checkbox"/> 50 x 53</td><td>51 x 51</td><td>1RHE2020C-SR</td></tr> </tbody> </table>	Misure cuscino LxP	Adatto a seduta LSxPS	Codice	<input type="checkbox"/> 43 x 43	43 x 41	1RHE1716C-SR	<input type="checkbox"/> 43 x 45	43 x 43	1RHE1717C-SR	<input type="checkbox"/> 43 x 48	43 x 46	1RHE1718C-SR	<input type="checkbox"/> 43 x 53	43 x 51	1RHE1720C-SR	<input type="checkbox"/> 45 x 43	46 x 41	1RHE1816C-SR	<input type="checkbox"/> 45 x 45	46 x 43	1RHE1817C-SR	<input type="checkbox"/> 45 x 48	46 x 46	1RHE1818C-SR	<input type="checkbox"/> 45 x 53	46 x 51	1RHE1820C-SR	<input type="checkbox"/> 50 x 45	51 x 43	1RHE2017C-SR	<input type="checkbox"/> 50 x 48	51 x 46	1RHE2018C-SR	<input type="checkbox"/> 50 x 53	51 x 51	1RHE2020C-SR	
Misure cuscino LxP	Adatto a seduta LSxPS	Codice																																																																								
<input type="checkbox"/> 35 x 37,5	36 x 36	1RHE1414C-SR																																																																								
<input type="checkbox"/> 35 x 40	36 x 38	1RHE1415C-SR																																																																								
<input type="checkbox"/> 35 x 43	36 x 41	1RHE1416C-SR																																																																								
<input type="checkbox"/> 37,5 x 40	38 x 38	1RHE1515C-SR																																																																								
<input type="checkbox"/> 37,5 x 43	38 x 41	1RHE1516C-SR																																																																								
<input type="checkbox"/> 37,5 x 45	38 x 43	1RHE1517C-SR																																																																								
<input type="checkbox"/> 40 x 40	41 x 38	1RHE1615C-SR																																																																								
<input type="checkbox"/> 40 x 43	41 x 41	1RHE1616C-SR																																																																								
<input type="checkbox"/> 40 x 45	41 x 43	1RHE1617C-SR																																																																								
<input type="checkbox"/> 40 x 48	41 x 46	1RHE1618C-SR																																																																								
<input type="checkbox"/> 40 x 53	41 x 51	1RHE1620C-SR																																																																								
Misure cuscino LxP	Adatto a seduta LSxPS	Codice																																																																								
<input type="checkbox"/> 43 x 43	43 x 41	1RHE1716C-SR																																																																								
<input type="checkbox"/> 43 x 45	43 x 43	1RHE1717C-SR																																																																								
<input type="checkbox"/> 43 x 48	43 x 46	1RHE1718C-SR																																																																								
<input type="checkbox"/> 43 x 53	43 x 51	1RHE1720C-SR																																																																								
<input type="checkbox"/> 45 x 43	46 x 41	1RHE1816C-SR																																																																								
<input type="checkbox"/> 45 x 45	46 x 43	1RHE1817C-SR																																																																								
<input type="checkbox"/> 45 x 48	46 x 46	1RHE1818C-SR																																																																								
<input type="checkbox"/> 45 x 53	46 x 51	1RHE1820C-SR																																																																								
<input type="checkbox"/> 50 x 45	51 x 43	1RHE2017C-SR																																																																								
<input type="checkbox"/> 50 x 48	51 x 46	1RHE2018C-SR																																																																								
<input type="checkbox"/> 50 x 53	51 x 51	1RHE2020C-SR																																																																								
ROHO® HYBRID ELITE® - Bivalvola /Bicompartimento - Limite di peso 225Kg			630,00																																																																							
<table border="1" style="width: 100%; border-collapse: collapse;"> <thead> <tr> <th>Misure cuscino LxP</th> <th>Adatto a seduta LSxPS</th> <th>Codice</th> </tr> </thead> <tbody> <tr><td><input type="checkbox"/> 35 x 37,5</td><td>36 x 36</td><td>2RHE1414C</td></tr> <tr><td><input type="checkbox"/> 35 x 40</td><td>36 x 38</td><td>2RHE1415C</td></tr> <tr><td><input type="checkbox"/> 35 x 43</td><td>36 x 41</td><td>2RHE1416C</td></tr> <tr><td><input type="checkbox"/> 37,5 x 40</td><td>38 x 38</td><td>2RHE1515C</td></tr> <tr><td><input type="checkbox"/> 37,5 x 43</td><td>38 x 41</td><td>2RHE1516C</td></tr> <tr><td><input type="checkbox"/> 37,5 x 45</td><td>38 x 43</td><td>2RHE1517C</td></tr> <tr><td><input type="checkbox"/> 40 x 40</td><td>41 x 38</td><td>2RHE1615C</td></tr> <tr><td><input type="checkbox"/> 40 x 43</td><td>41 x 41</td><td>2RHE1616C</td></tr> <tr><td><input type="checkbox"/> 40 x 45</td><td>41 x 43</td><td>2RHE1617C</td></tr> <tr><td><input type="checkbox"/> 40 x 48</td><td>41 x 46</td><td>2RHE1618C</td></tr> <tr><td><input type="checkbox"/> 40 x 53</td><td>41 x 51</td><td>2RHE1620C</td></tr> </tbody> </table>	Misure cuscino LxP	Adatto a seduta LSxPS	Codice	<input type="checkbox"/> 35 x 37,5	36 x 36	2RHE1414C	<input type="checkbox"/> 35 x 40	36 x 38	2RHE1415C	<input type="checkbox"/> 35 x 43	36 x 41	2RHE1416C	<input type="checkbox"/> 37,5 x 40	38 x 38	2RHE1515C	<input type="checkbox"/> 37,5 x 43	38 x 41	2RHE1516C	<input type="checkbox"/> 37,5 x 45	38 x 43	2RHE1517C	<input type="checkbox"/> 40 x 40	41 x 38	2RHE1615C	<input type="checkbox"/> 40 x 43	41 x 41	2RHE1616C	<input type="checkbox"/> 40 x 45	41 x 43	2RHE1617C	<input type="checkbox"/> 40 x 48	41 x 46	2RHE1618C	<input type="checkbox"/> 40 x 53	41 x 51	2RHE1620C	<table border="1" style="width: 100%; border-collapse: collapse;"> <thead> <tr> <th>Misure cuscino LxP</th> <th>Adatto a seduta LSxPS</th> <th>Codice</th> </tr> </thead> <tbody> <tr><td><input type="checkbox"/> 43 x 43</td><td>43 x 41</td><td>2RHE1716C</td></tr> <tr><td><input type="checkbox"/> 43 x 45</td><td>43 x 43</td><td>2RHE1717C</td></tr> <tr><td><input type="checkbox"/> 43 x 48</td><td>43 x 46</td><td>2RHE1718C</td></tr> <tr><td><input type="checkbox"/> 43 x 53</td><td>43 x 51</td><td>2RHE1720C</td></tr> <tr><td><input type="checkbox"/> 45 x 43</td><td>46 x 41</td><td>2RHE1816C</td></tr> <tr><td><input type="checkbox"/> 45 x 45</td><td>46 x 43</td><td>2RHE1817C</td></tr> <tr><td><input type="checkbox"/> 45 x 48</td><td>46 x 46</td><td>2RHE1818C</td></tr> <tr><td><input type="checkbox"/> 45 x 53</td><td>46 x 51</td><td>2RHE1820C</td></tr> <tr><td><input type="checkbox"/> 50 x 45</td><td>51 x 43</td><td>2RHE2017C</td></tr> <tr><td><input type="checkbox"/> 50 x 48</td><td>51 x 46</td><td>2RHE2018C</td></tr> <tr><td><input type="checkbox"/> 50 x 53</td><td>51 x 51</td><td>2RHE2020C</td></tr> </tbody> </table>	Misure cuscino LxP	Adatto a seduta LSxPS	Codice	<input type="checkbox"/> 43 x 43	43 x 41	2RHE1716C	<input type="checkbox"/> 43 x 45	43 x 43	2RHE1717C	<input type="checkbox"/> 43 x 48	43 x 46	2RHE1718C	<input type="checkbox"/> 43 x 53	43 x 51	2RHE1720C	<input type="checkbox"/> 45 x 43	46 x 41	2RHE1816C	<input type="checkbox"/> 45 x 45	46 x 43	2RHE1817C	<input type="checkbox"/> 45 x 48	46 x 46	2RHE1818C	<input type="checkbox"/> 45 x 53	46 x 51	2RHE1820C	<input type="checkbox"/> 50 x 45	51 x 43	2RHE2017C	<input type="checkbox"/> 50 x 48	51 x 46	2RHE2018C	<input type="checkbox"/> 50 x 53	51 x 51	2RHE2020C	
Misure cuscino LxP	Adatto a seduta LSxPS	Codice																																																																								
<input type="checkbox"/> 35 x 37,5	36 x 36	2RHE1414C																																																																								
<input type="checkbox"/> 35 x 40	36 x 38	2RHE1415C																																																																								
<input type="checkbox"/> 35 x 43	36 x 41	2RHE1416C																																																																								
<input type="checkbox"/> 37,5 x 40	38 x 38	2RHE1515C																																																																								
<input type="checkbox"/> 37,5 x 43	38 x 41	2RHE1516C																																																																								
<input type="checkbox"/> 37,5 x 45	38 x 43	2RHE1517C																																																																								
<input type="checkbox"/> 40 x 40	41 x 38	2RHE1615C																																																																								
<input type="checkbox"/> 40 x 43	41 x 41	2RHE1616C																																																																								
<input type="checkbox"/> 40 x 45	41 x 43	2RHE1617C																																																																								
<input type="checkbox"/> 40 x 48	41 x 46	2RHE1618C																																																																								
<input type="checkbox"/> 40 x 53	41 x 51	2RHE1620C																																																																								
Misure cuscino LxP	Adatto a seduta LSxPS	Codice																																																																								
<input type="checkbox"/> 43 x 43	43 x 41	2RHE1716C																																																																								
<input type="checkbox"/> 43 x 45	43 x 43	2RHE1717C																																																																								
<input type="checkbox"/> 43 x 48	43 x 46	2RHE1718C																																																																								
<input type="checkbox"/> 43 x 53	43 x 51	2RHE1720C																																																																								
<input type="checkbox"/> 45 x 43	46 x 41	2RHE1816C																																																																								
<input type="checkbox"/> 45 x 45	46 x 43	2RHE1817C																																																																								
<input type="checkbox"/> 45 x 48	46 x 46	2RHE1818C																																																																								
<input type="checkbox"/> 45 x 53	46 x 51	2RHE1820C																																																																								
<input type="checkbox"/> 50 x 45	51 x 43	2RHE2017C																																																																								
<input type="checkbox"/> 50 x 48	51 x 46	2RHE2018C																																																																								
<input type="checkbox"/> 50 x 53	51 x 51	2RHE2020C																																																																								
ROHO® HYBRID SELECT®			630,00																																																																							
<table border="1" style="width: 100%; border-collapse: collapse;"> <thead> <tr> <th>Misure cuscino LxP</th> <th>Adatto a seduta LSxPS</th> <th>Codice</th> </tr> </thead> <tbody> <tr><td><input type="checkbox"/> 35,5 x 37,5</td><td>36x38</td><td>HS1414C</td></tr> <tr><td><input type="checkbox"/> 35,5 x 42,5</td><td>36x43</td><td>HS1416C</td></tr> <tr><td><input type="checkbox"/> 38 x 40</td><td>38x40</td><td>HS1515C</td></tr> <tr><td><input type="checkbox"/> 38 x 42,5</td><td>38x43</td><td>HS1516C</td></tr> <tr><td><input type="checkbox"/> 38 x 45</td><td>38x45</td><td>HS1517C</td></tr> <tr><td><input type="checkbox"/> 40,5 x 40</td><td>41x40</td><td>HS1615C</td></tr> <tr><td><input type="checkbox"/> 40,5 x 42,5</td><td>41x43</td><td>HS1616C</td></tr> <tr><td><input type="checkbox"/> 40,5 x 45</td><td>41x45</td><td>HS1617C</td></tr> <tr><td><input type="checkbox"/> 40,5 x 47,5</td><td>41x48</td><td>HS1618C</td></tr> <tr><td><input type="checkbox"/> 40,5 x 52,5</td><td>41x53</td><td>HS1620C</td></tr> <tr><td><input type="checkbox"/> 43 x 42,5</td><td>43x43</td><td>HS1716C</td></tr> </tbody> </table>	Misure cuscino LxP	Adatto a seduta LSxPS	Codice	<input type="checkbox"/> 35,5 x 37,5	36x38	HS1414C	<input type="checkbox"/> 35,5 x 42,5	36x43	HS1416C	<input type="checkbox"/> 38 x 40	38x40	HS1515C	<input type="checkbox"/> 38 x 42,5	38x43	HS1516C	<input type="checkbox"/> 38 x 45	38x45	HS1517C	<input type="checkbox"/> 40,5 x 40	41x40	HS1615C	<input type="checkbox"/> 40,5 x 42,5	41x43	HS1616C	<input type="checkbox"/> 40,5 x 45	41x45	HS1617C	<input type="checkbox"/> 40,5 x 47,5	41x48	HS1618C	<input type="checkbox"/> 40,5 x 52,5	41x53	HS1620C	<input type="checkbox"/> 43 x 42,5	43x43	HS1716C	<table border="1" style="width: 100%; border-collapse: collapse;"> <thead> <tr> <th>Misure cuscino LxP</th> <th>Adatto a seduta LSxPS</th> <th>Codice</th> </tr> </thead> <tbody> <tr><td><input type="checkbox"/> 43 x 45</td><td>43x45</td><td>HS1717C</td></tr> <tr><td><input type="checkbox"/> 43 x 47,5</td><td>43x48</td><td>HS1718C</td></tr> <tr><td><input type="checkbox"/> 43 x 52,5</td><td>43x53</td><td>HS1720C</td></tr> <tr><td><input type="checkbox"/> 45,5 x 42,5</td><td>46x43</td><td>HS1816C</td></tr> <tr><td><input type="checkbox"/> 45,5 x 45</td><td>46x45</td><td>HS1817C</td></tr> <tr><td><input type="checkbox"/> 45,5 x 47,5</td><td>46x48</td><td>HS1818C</td></tr> <tr><td><input type="checkbox"/> 45,5 x 52,5</td><td>46x53</td><td>HS1820C</td></tr> <tr><td><input type="checkbox"/> 51 x 42,5</td><td>51x43</td><td>HS2016C</td></tr> <tr><td><input type="checkbox"/> 51 x 45</td><td>51x45</td><td>HS2017C</td></tr> <tr><td><input type="checkbox"/> 51 x 47,5</td><td>51x48</td><td>HS2018C</td></tr> <tr><td><input type="checkbox"/> 51 x 52,5</td><td>51x53</td><td>HS2020C</td></tr> </tbody> </table>	Misure cuscino LxP	Adatto a seduta LSxPS	Codice	<input type="checkbox"/> 43 x 45	43x45	HS1717C	<input type="checkbox"/> 43 x 47,5	43x48	HS1718C	<input type="checkbox"/> 43 x 52,5	43x53	HS1720C	<input type="checkbox"/> 45,5 x 42,5	46x43	HS1816C	<input type="checkbox"/> 45,5 x 45	46x45	HS1817C	<input type="checkbox"/> 45,5 x 47,5	46x48	HS1818C	<input type="checkbox"/> 45,5 x 52,5	46x53	HS1820C	<input type="checkbox"/> 51 x 42,5	51x43	HS2016C	<input type="checkbox"/> 51 x 45	51x45	HS2017C	<input type="checkbox"/> 51 x 47,5	51x48	HS2018C	<input type="checkbox"/> 51 x 52,5	51x53	HS2020C	
Misure cuscino LxP	Adatto a seduta LSxPS	Codice																																																																								
<input type="checkbox"/> 35,5 x 37,5	36x38	HS1414C																																																																								
<input type="checkbox"/> 35,5 x 42,5	36x43	HS1416C																																																																								
<input type="checkbox"/> 38 x 40	38x40	HS1515C																																																																								
<input type="checkbox"/> 38 x 42,5	38x43	HS1516C																																																																								
<input type="checkbox"/> 38 x 45	38x45	HS1517C																																																																								
<input type="checkbox"/> 40,5 x 40	41x40	HS1615C																																																																								
<input type="checkbox"/> 40,5 x 42,5	41x43	HS1616C																																																																								
<input type="checkbox"/> 40,5 x 45	41x45	HS1617C																																																																								
<input type="checkbox"/> 40,5 x 47,5	41x48	HS1618C																																																																								
<input type="checkbox"/> 40,5 x 52,5	41x53	HS1620C																																																																								
<input type="checkbox"/> 43 x 42,5	43x43	HS1716C																																																																								
Misure cuscino LxP	Adatto a seduta LSxPS	Codice																																																																								
<input type="checkbox"/> 43 x 45	43x45	HS1717C																																																																								
<input type="checkbox"/> 43 x 47,5	43x48	HS1718C																																																																								
<input type="checkbox"/> 43 x 52,5	43x53	HS1720C																																																																								
<input type="checkbox"/> 45,5 x 42,5	46x43	HS1816C																																																																								
<input type="checkbox"/> 45,5 x 45	46x45	HS1817C																																																																								
<input type="checkbox"/> 45,5 x 47,5	46x48	HS1818C																																																																								
<input type="checkbox"/> 45,5 x 52,5	46x53	HS1820C																																																																								
<input type="checkbox"/> 51 x 42,5	51x43	HS2016C																																																																								
<input type="checkbox"/> 51 x 45	51x45	HS2017C																																																																								
<input type="checkbox"/> 51 x 47,5	51x48	HS2018C																																																																								
<input type="checkbox"/> 51 x 52,5	51x53	HS2020C																																																																								
ROHO® MONOCOMPARTIMENT® High Profile® altezza 10 cm			370,00																																																																							
<table border="1" style="width: 100%; border-collapse: collapse;"> <thead> <tr> <th>Misure cuscino LxP</th> <th>Adatto a seduta LSxPS</th> <th>Codice</th> </tr> </thead> <tbody> <tr><td><input type="checkbox"/> 30 x 30 - (6 x 6)</td><td>26,5+31 x 26,5+31</td><td>1R66C</td></tr> <tr><td><input type="checkbox"/> 30 x 33 - (6 x 7)</td><td>26,5+31 x 31+35</td><td>1R67C</td></tr> <tr><td><input type="checkbox"/> 33 x 33 - (7 x 7)</td><td>31+35 x 31+35</td><td>1R77C</td></tr> <tr><td><input type="checkbox"/> 33 x 38 - (7 x 8)</td><td>31+35 x 35+39,5</td><td>1R78C</td></tr> <tr><td><input type="checkbox"/> 33 x 42 - (7 x 9)</td><td>31+35 x 39,5+44</td><td>1R79C</td></tr> <tr><td><input type="checkbox"/> 38 x 33 - (8 x 7)</td><td>35+39,5 x 31+35</td><td>1R87C</td></tr> <tr><td><input type="checkbox"/> 38 x 38 - (8 x 8)</td><td>35+39,5 x 35+39,5</td><td>1R88C</td></tr> <tr><td><input type="checkbox"/> 38 x 42 - (8 x 9)</td><td>35+39,5 x 39,5+44</td><td>1R89C</td></tr> <tr><td><input type="checkbox"/> 38 x 46 - (8 x 10)</td><td>35+39,5 x 44+48,5</td><td>1R810C</td></tr> <tr><td><input type="checkbox"/> 42 x 38 - (9 x 8)</td><td>39,5+44 x 35+39,5</td><td>1R98C</td></tr> <tr><td><input type="checkbox"/> 42 x 42 - (9 x 9)</td><td>39,5+44 x 39,5+44</td><td>1R99C</td></tr> </tbody> </table>	Misure cuscino LxP	Adatto a seduta LSxPS	Codice	<input type="checkbox"/> 30 x 30 - (6 x 6)	26,5+31 x 26,5+31	1R66C	<input type="checkbox"/> 30 x 33 - (6 x 7)	26,5+31 x 31+35	1R67C	<input type="checkbox"/> 33 x 33 - (7 x 7)	31+35 x 31+35	1R77C	<input type="checkbox"/> 33 x 38 - (7 x 8)	31+35 x 35+39,5	1R78C	<input type="checkbox"/> 33 x 42 - (7 x 9)	31+35 x 39,5+44	1R79C	<input type="checkbox"/> 38 x 33 - (8 x 7)	35+39,5 x 31+35	1R87C	<input type="checkbox"/> 38 x 38 - (8 x 8)	35+39,5 x 35+39,5	1R88C	<input type="checkbox"/> 38 x 42 - (8 x 9)	35+39,5 x 39,5+44	1R89C	<input type="checkbox"/> 38 x 46 - (8 x 10)	35+39,5 x 44+48,5	1R810C	<input type="checkbox"/> 42 x 38 - (9 x 8)	39,5+44 x 35+39,5	1R98C	<input type="checkbox"/> 42 x 42 - (9 x 9)	39,5+44 x 39,5+44	1R99C	<table border="1" style="width: 100%; border-collapse: collapse;"> <thead> <tr> <th>Misure cuscino LxP</th> <th>Adatto a seduta LSxPS</th> <th>Codice</th> </tr> </thead> <tbody> <tr><td><input type="checkbox"/> 42 x 46 - (9 x 10)</td><td>39,5+44 x 44+48,5</td><td>1R910C</td></tr> <tr><td><input type="checkbox"/> 42 x 51 - (9 x 11)</td><td>39,5+44 x 48,5+52,5</td><td>1R911C</td></tr> <tr><td><input type="checkbox"/> 46 x 38 - (10 x 8)</td><td>44+48,5 x 35+39,5</td><td>1R108C</td></tr> <tr><td><input type="checkbox"/> 46 x 42 - (10 x 9)</td><td>44+48,5 x 39,5+44</td><td>1R109C</td></tr> <tr><td><input type="checkbox"/> 46 x 46 - (10 x 10)</td><td>44+48,5 x 44+48,5</td><td>1R1010C</td></tr> <tr><td><input type="checkbox"/> 46 x 51 - (10 x 11)</td><td>44+48,5 x 48,5+52,5</td><td>1R1011C</td></tr> <tr><td><input type="checkbox"/> 46 x 56 - (10 x 12)</td><td>44+48,5 x 52,5+57</td><td>1R1012C</td></tr> <tr><td><input type="checkbox"/> 51 x 42 - (11 x 9)</td><td>48,5+52,5 x 39,5+44</td><td>1R119C</td></tr> <tr><td><input type="checkbox"/> 51 x 46 - (11 x 10)</td><td>48,5+52,5 x 44+48,5</td><td>1R1110C</td></tr> <tr><td><input type="checkbox"/> 51 x 51 - (11 x 11)</td><td>48,5+52,5 x 48,5+52,5</td><td>1R1111C</td></tr> <tr><td><input type="checkbox"/> 51 x 56 - (11 x 12)</td><td>48,5+52,5 x 52,5+57</td><td>1R1112C</td></tr> </tbody> </table>	Misure cuscino LxP	Adatto a seduta LSxPS	Codice	<input type="checkbox"/> 42 x 46 - (9 x 10)	39,5+44 x 44+48,5	1R910C	<input type="checkbox"/> 42 x 51 - (9 x 11)	39,5+44 x 48,5+52,5	1R911C	<input type="checkbox"/> 46 x 38 - (10 x 8)	44+48,5 x 35+39,5	1R108C	<input type="checkbox"/> 46 x 42 - (10 x 9)	44+48,5 x 39,5+44	1R109C	<input type="checkbox"/> 46 x 46 - (10 x 10)	44+48,5 x 44+48,5	1R1010C	<input type="checkbox"/> 46 x 51 - (10 x 11)	44+48,5 x 48,5+52,5	1R1011C	<input type="checkbox"/> 46 x 56 - (10 x 12)	44+48,5 x 52,5+57	1R1012C	<input type="checkbox"/> 51 x 42 - (11 x 9)	48,5+52,5 x 39,5+44	1R119C	<input type="checkbox"/> 51 x 46 - (11 x 10)	48,5+52,5 x 44+48,5	1R1110C	<input type="checkbox"/> 51 x 51 - (11 x 11)	48,5+52,5 x 48,5+52,5	1R1111C	<input type="checkbox"/> 51 x 56 - (11 x 12)	48,5+52,5 x 52,5+57	1R1112C	
Misure cuscino LxP	Adatto a seduta LSxPS	Codice																																																																								
<input type="checkbox"/> 30 x 30 - (6 x 6)	26,5+31 x 26,5+31	1R66C																																																																								
<input type="checkbox"/> 30 x 33 - (6 x 7)	26,5+31 x 31+35	1R67C																																																																								
<input type="checkbox"/> 33 x 33 - (7 x 7)	31+35 x 31+35	1R77C																																																																								
<input type="checkbox"/> 33 x 38 - (7 x 8)	31+35 x 35+39,5	1R78C																																																																								
<input type="checkbox"/> 33 x 42 - (7 x 9)	31+35 x 39,5+44	1R79C																																																																								
<input type="checkbox"/> 38 x 33 - (8 x 7)	35+39,5 x 31+35	1R87C																																																																								
<input type="checkbox"/> 38 x 38 - (8 x 8)	35+39,5 x 35+39,5	1R88C																																																																								
<input type="checkbox"/> 38 x 42 - (8 x 9)	35+39,5 x 39,5+44	1R89C																																																																								
<input type="checkbox"/> 38 x 46 - (8 x 10)	35+39,5 x 44+48,5	1R810C																																																																								
<input type="checkbox"/> 42 x 38 - (9 x 8)	39,5+44 x 35+39,5	1R98C																																																																								
<input type="checkbox"/> 42 x 42 - (9 x 9)	39,5+44 x 39,5+44	1R99C																																																																								
Misure cuscino LxP	Adatto a seduta LSxPS	Codice																																																																								
<input type="checkbox"/> 42 x 46 - (9 x 10)	39,5+44 x 44+48,5	1R910C																																																																								
<input type="checkbox"/> 42 x 51 - (9 x 11)	39,5+44 x 48,5+52,5	1R911C																																																																								
<input type="checkbox"/> 46 x 38 - (10 x 8)	44+48,5 x 35+39,5	1R108C																																																																								
<input type="checkbox"/> 46 x 42 - (10 x 9)	44+48,5 x 39,5+44	1R109C																																																																								
<input type="checkbox"/> 46 x 46 - (10 x 10)	44+48,5 x 44+48,5	1R1010C																																																																								
<input type="checkbox"/> 46 x 51 - (10 x 11)	44+48,5 x 48,5+52,5	1R1011C																																																																								
<input type="checkbox"/> 46 x 56 - (10 x 12)	44+48,5 x 52,5+57	1R1012C																																																																								
<input type="checkbox"/> 51 x 42 - (11 x 9)	48,5+52,5 x 39,5+44	1R119C																																																																								
<input type="checkbox"/> 51 x 46 - (11 x 10)	48,5+52,5 x 44+48,5	1R1110C																																																																								
<input type="checkbox"/> 51 x 51 - (11 x 11)	48,5+52,5 x 48,5+52,5	1R1111C																																																																								
<input type="checkbox"/> 51 x 56 - (11 x 12)	48,5+52,5 x 52,5+57	1R1112C																																																																								

Data Compressa Utilizzatore Indirizzo

O ROHO® MONOCOMPARTIMENT® Low Profile® altezza 5 cm **370,00**

Misure cuscino LxP	Adatto a seduta LSxPS	Codice	Misure cuscino LxP	Adatto a seduta LSxPS	Codice
<input type="checkbox"/> 30 x 30 - (6 x 6)	26,5+31 x 26,5+31	1R66LPC	<input type="checkbox"/> 42 x 42 - (9 x 9)	39,5+44 x 39,5+44	1R99LPC
<input type="checkbox"/> 30 x 33 - (6 x 7)	26,5+31 x 31+35	1R67LPC	<input type="checkbox"/> 42 x 46 - (9 x 10)	39,5+44 x 44+48,5	1R910LPC
<input type="checkbox"/> 33 x 33 - (7 x 7)	31+35 x 31+35	1R77LPC	<input type="checkbox"/> 42 x 51 - (9 x 11)	39,5+44 x 48,5+52,5	1R911LPC
<input type="checkbox"/> 33 x 38 - (7 x 8)	31+35 x 35+39,5	1R78LPC	<input type="checkbox"/> 46 x 38 - (10 x 8)	44+48,5 x 35+39,5	1R108LPC
<input type="checkbox"/> 33 x 42 - (7 x 9)	31+35 x 39,5+44	1R79LPC	<input type="checkbox"/> 46 x 42 - (10 x 9)	44+48,5 x 39,5+44	1R109LPC
<input type="checkbox"/> 38 x 33 - (8 x 7)	35+39,5 x 31+35	1R87LPC	<input type="checkbox"/> 46 x 46 - (10 x 10)	44+48,5 x 44+48,5	1R1010LPC
<input type="checkbox"/> 38 x 38 - (8 x 8)	35+39,5 x 35+39,5	1R88LPC	<input type="checkbox"/> 46 x 51 - (10 x 11)	44+48,5 x 48,5+52,5	1R1011LPC
<input type="checkbox"/> 38 x 42 - (8 x 9)	35+39,5 x 39,5+44	1R89LPC	<input type="checkbox"/> 51 x 42 - (11 x 9)	48,5+52,5 x 39,5+44	1R119LPC
<input type="checkbox"/> 38 x 46 - (8 x 10)	35+39,5 x 44+48,5	1R810LPC	<input type="checkbox"/> 51 x 46 - (11 x 10)	48,5+52,5 x 44+48,5	1R1110LPC
<input type="checkbox"/> 42 x 38 - (9 x 8)	39,5+44 x 35+39,5	1R98LPC	<input type="checkbox"/> 51 x 51 - (11 x 11)	48,5+52,5 x 48,5+52,5	1R1111LPC



O ROHO® QUADTRO SELECT® High Profile® altezza 10 cm **630,00**

Misure cuscino LxP	Adatto a seduta LSxPS	Codice	Misure cuscino LxP	Adatto a seduta LSxPS	Codice
<input type="checkbox"/> 30 x 30 - (6 x 6)	26,5+31 x 26,5+31	QS66C	<input type="checkbox"/> 42 x 46 - (9 x 10)	39,5+44 x 44+48,5	QS910C
<input type="checkbox"/> 30 x 33 - (6 x 7)	26,5+31 x 31+35	QS67C	<input type="checkbox"/> 42 x 51 - (9 x 11)	39,5+44 x 48,5+52,5	QS911C
<input type="checkbox"/> 33 x 33 - (7 x 7)	31+35 x 31+35	QS77C	<input type="checkbox"/> 42 x 56 - (9 x 12)	39,5+44 x 52,5+57	QS912C
<input type="checkbox"/> 33 x 38 - (7 x 8)	31+35 x 35+39,5	QS78C	<input type="checkbox"/> 46 x 38 - (10 x 8)	44+48,5 x 35+39,5	QS108C
<input type="checkbox"/> 33 x 42 - (7 x 9)	31+35 x 39,5+44	QS79C	<input type="checkbox"/> 46 x 42 - (10 x 9)	44+48,5 x 39,5+44	QS109C
<input type="checkbox"/> 38 x 33 - (8 x 7)	35+39,5 x 31+35	QS87C	<input type="checkbox"/> 46 x 46 - (10 x 10)	44+48,5 x 44+48,5	QS1010C
<input type="checkbox"/> 38 x 38 - (8 x 8)	35+39,5 x 35+39,5	QS88C	<input type="checkbox"/> 46 x 51 - (10 x 11)	44+48,5 x 48,5+52,5	QS1011C
<input type="checkbox"/> 38 x 42 - (8 x 9)	35+39,5 x 39,5+44	QS89C	<input type="checkbox"/> 46 x 56 - (10 x 12)	44+48,5 x 52,5+57	QS1012C
<input type="checkbox"/> 38 x 46 - (8 x 10)	35+39,5 x 44+48,5	QS810C	<input type="checkbox"/> 51 x 42 - (11 x 9)	48,5+52,5 x 39,5+44	QS119C
<input type="checkbox"/> 42 x 38 - (9 x 8)	39,5+44 x 35+39,5	QS98C	<input type="checkbox"/> 51 x 46 - (11 x 10)	48,5+52,5 x 44+48,5	QS1110C
<input type="checkbox"/> 42 x 42 - (9 x 9)	39,5+44 x 39,5+44	QS99C	<input type="checkbox"/> 51 x 51 - (11 x 11)	48,5+52,5 x 48,5+52,5	QS1111C



O ROHO® QUADTRO SELECT® Low Profile® altezza 5 cm **630,00**

Misure cuscino LxP	Adatto a seduta LSxPS	Codice	Misure cuscino LxP	Adatto a seduta LSxPS	Codice
<input type="checkbox"/> 28 x 30 - (5 x 6)	22+26,5 x 26,5+31	QS56LPC	<input type="checkbox"/> 42 x 42 - (9 x 9)	39,5+44 x 39,5+44	QS99LPC
<input type="checkbox"/> 30 x 30 - (6 x 6)	26,5+31 x 26,5+31	QS66LPC	<input type="checkbox"/> 42 x 46 - (9 x 10)	39,5+44 x 44+48,5	QS910LPC
<input type="checkbox"/> 30 x 33 - (6 x 7)	26,5+31 x 31+35	QS67LPC	<input type="checkbox"/> 42 x 51 - (9 x 11)	39,5+44 x 48,5+52,5	QS911LPC
<input type="checkbox"/> 33 x 33 - (7 x 7)	31+35 x 31+35	QS77LPC	<input type="checkbox"/> 46 x 38 - (10 x 8)	44+48,5 x 35+39,5	QS108LPC
<input type="checkbox"/> 33 x 38 - (7 x 8)	31+35 x 35+39,5	QS78LPC	<input type="checkbox"/> 46 x 42 - (10 x 9)	44+48,5 x 39,5+44	QS109LPC
<input type="checkbox"/> 33 x 42 - (7 x 9)	31+35 x 39,5+44	QS79LPC	<input type="checkbox"/> 46 x 46 - (10 x 10)	44+48,5 x 44+48,5	QS1010LPC
<input type="checkbox"/> 38 x 33 - (8 x 7)	35+39,5 x 31+35	QS87LPC	<input type="checkbox"/> 46 x 51 - (10 x 11)	44+48,5 x 48,5+52,5	QS1011LPC
<input type="checkbox"/> 38 x 38 - (8 x 8)	35+39,5 x 35+39,5	QS88LPC	<input type="checkbox"/> 51 x 42 - (11 x 9)	48,5+52,5 x 39,5+44	QS119LPC
<input type="checkbox"/> 38 x 42 - (8 x 9)	35+39,5 x 39,5+44	QS89LPC	<input type="checkbox"/> 51 x 46 - (11 x 10)	48,5+52,5 x 44+48,5	QS1110LPC
<input type="checkbox"/> 38 x 46 - (8 x 10)	35+39,5 x 44+48,5	QS810LPC	<input type="checkbox"/> 51 x 51 - (11 x 11)	48,5+52,5 x 48,5+52,5	QS1111LPC
<input type="checkbox"/> 42 x 38 - (9 x 8)	39,5+44 x 35+39,5	QS98LPC			

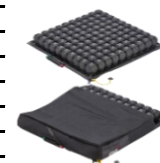

O ROHO® CONTOUR SELECT® **630,00**

Misure cuscino LxP	Adatto a seduta LSxPS	Codice	Misure cuscino LxP	Adatto a seduta LSxPS	Codice
<input type="checkbox"/> 33 x 38 - (7 x 8)	31+35 x 35+39,5	CS78C	<input type="checkbox"/> 42 x 51 - (9 x 11)	39,5+44 x 48,5+52,5	CS911C
<input type="checkbox"/> 38 x 38 - (8 x 8)	35+39,5 x 35+39,5	CS88C	<input type="checkbox"/> 46 x 42 - (10 x 9)	44+48,5 x 39,5+44	CS109C
<input type="checkbox"/> 38 x 42 - (8 x 9)	35+39,5 x 39,5+44	CS89C	<input type="checkbox"/> 46 x 46 - (10 x 10)	44+48,5 x 44+48,5	CS1010C
<input type="checkbox"/> 38 x 46 - (8 x 10)	35+39,5 x 44+48,5	CS810C	<input type="checkbox"/> 46 x 51 - (10 x 11)	44+48,5 x 48,5+52,5	CS1011C
<input type="checkbox"/> 42 x 38 - (9 x 8)	39,5+44 x 35+39,5	CS98C	<input type="checkbox"/> 51 x 42 - (11 x 9)	48,5+52,5 x 39,5+44	CS119C
<input type="checkbox"/> 42 x 42 - (9 x 9)	39,5+44 x 39,5+44	CS99C	<input type="checkbox"/> 51 x 46 - (11 x 10)	48,5+52,5 x 44+48,5	CS1110C
<input type="checkbox"/> 42 x 46 - (9 x 10)	39,5+44 x 44+48,5	CS910C	<input type="checkbox"/> 51 x 51 - (11 x 11)	48,5+52,5 x 48,5+52,5	CS1111C



O ROHO® ENHANCER® **630,00**

Misure cuscino LxP	Adatto a seduta LSxPS	Codice	Misure cuscino LxP	Adatto a seduta LSxPS	Codice
<input type="checkbox"/> 38 x 38 - (8 x 8)	35+39,5 x 35+39,5	ENH88C	<input type="checkbox"/> 46 x 42 - (10 x 9)	44+48,5 x 39,5+44	ENH109C
<input type="checkbox"/> 38 x 42 - (8 x 9)	35+39,5 x 39,5+44	ENH89C	<input type="checkbox"/> 46 x 46 - (10 x 10)	44+48,5 x 44+48,5	ENH1010C
<input type="checkbox"/> 42 x 38 - (9 x 8)	39,5+44 x 35+39,5	ENH98C	<input type="checkbox"/> 46 x 51 - (10 x 11)	44+48,5 x 48,5+52,5	ENH1011C
<input type="checkbox"/> 42 x 42 - (9 x 9)	39,5+44 x 39,5+44	ENH99C	<input type="checkbox"/> 51 x 46 - (11 x 10)	48,5+52,5 x 44+48,5	ENH1110C
<input type="checkbox"/> 42 x 46 - (9 x 10)	39,5+44 x 44+48,5	ENH910C			



Carrozina : Progeo JOKER JUNIOR 2.0 - Rev. 2026.0

Prezzo IVA esclusa
da sommare al prezzo di listino

Pagina da inviare se sono stati scelti optional

standard (fornito in assenza di altre indicazioni)

su richiesta (senza aggiunta di prezzo)

optional (sommare il prezzo a quello di listino)

Stampato il

Permobil Progeo Active Design s.r.l. - a Socio Unico - Vicolo L. Negrelli, 5 - 31038 Paese (TV) - Tel. +39 0422 484657
 P.IVA, Codice Fiscale e Numero di iscrizione al Registro Imprese di Treviso 10246110968 - Fatturazione Elettronica: Codice Destinatario A4707H7 - Capitale Sociale I.V. € 10.000,00

Email: info_fi@permobil.com - web: http://www.rehateamprogeo.com

Data Commessa Utilizzatore Indirizzo

SMARTDRIVE - compreso di caricabatteria



SWITCH CONTROL (DX+SX) - EU Funzionamento a due pulsanti	<input type="radio"/> 6 KM/H	MX2-S002	4.000,00
	<input type="radio"/> 9 KM/H	MX2-S005	4.100,00
SWITCH CONTROL + JACK 3.5 - EU Un pulsante e un ingresso femmina Mono che permette di collegare SmartDrive con un qualsiasi altro dispositivo di comando/guida.	<input type="radio"/> 6 KM/H	MX2-S003	4.000,00
	<input type="radio"/> 9 KM/H	MX2-S006	4.100,00

Pulsante di comando esterno BUDDY BUTTON
 completo di adattatore, set di montaggio e braccio di estensione
Disponibile solo con SWITCH CONTROL + JACK 3.5



MX2-BBB 250,00

KIT FISSAGGIO TELAIO RIGIDO

Scegliere kit di fissaggio in funzione della misura delle ruote posteriori della carrozzina

- kit fissaggio telaio rigido - ruote posteriori 22" - 24" MX2-44S-C
- kit fissaggio telaio rigido - ruote posteriori 25" MX2-45S-C
- kit fissaggio telaio rigido - ruote posteriori 26" MX2-46S-C

SMART WATCH

Lo SmartDrive può essere comandato e gestito con uno Smart Watch APPLE o GALAXY
 Configurazione semplice e veloce
 Maggiore visibilità dello schermo
 Prestazioni della batteria migliorate
 App gratuita su Apple Store e Play Store

Lista compatibilità'



Smart Watch compatibili

APPLE WATCH
 serie 5 o successivi con iOS 8 o successivi
 Apple iPhone

GALAXY WATCH
 serie 4 o successivi
 Smartphone Samsung
 Smartphone Android 6.0 e RAM almeno 1.5 GB

Applicazioni gratuite

SmartDrive MX2+



Pushtracker



Accessori

Borsa da trasporto



MX2SD-BAG 60,00

Maniglia universale imbottita
Maniglia universale imbottita



MX2-986 20,00

Carrozzina : Progeo JOKER JUNIOR 2.0 - Rev. 2026.0

Prezzo IVA esclusa
 da sommare al prezzo di listino

Pagina da inviare se sono stati scelti optional

- standard** (fornito in assenza di altre indicazioni)
- su richiesta** (senza aggiunta di prezzo)
- optional** (sommare il prezzo a quello di listino)