

English  
Company stamp

Rigid frame wheelchair

Date .....

User name .....

Responsible .....

**Carbon fibre frame made-to-measure.**

Keep attention to all measures.

**NOIR is a wheelchair without possibilities of adjustments after its manufacturing.**

See reference tables

Take care to write all the requested measures (in centimetres)

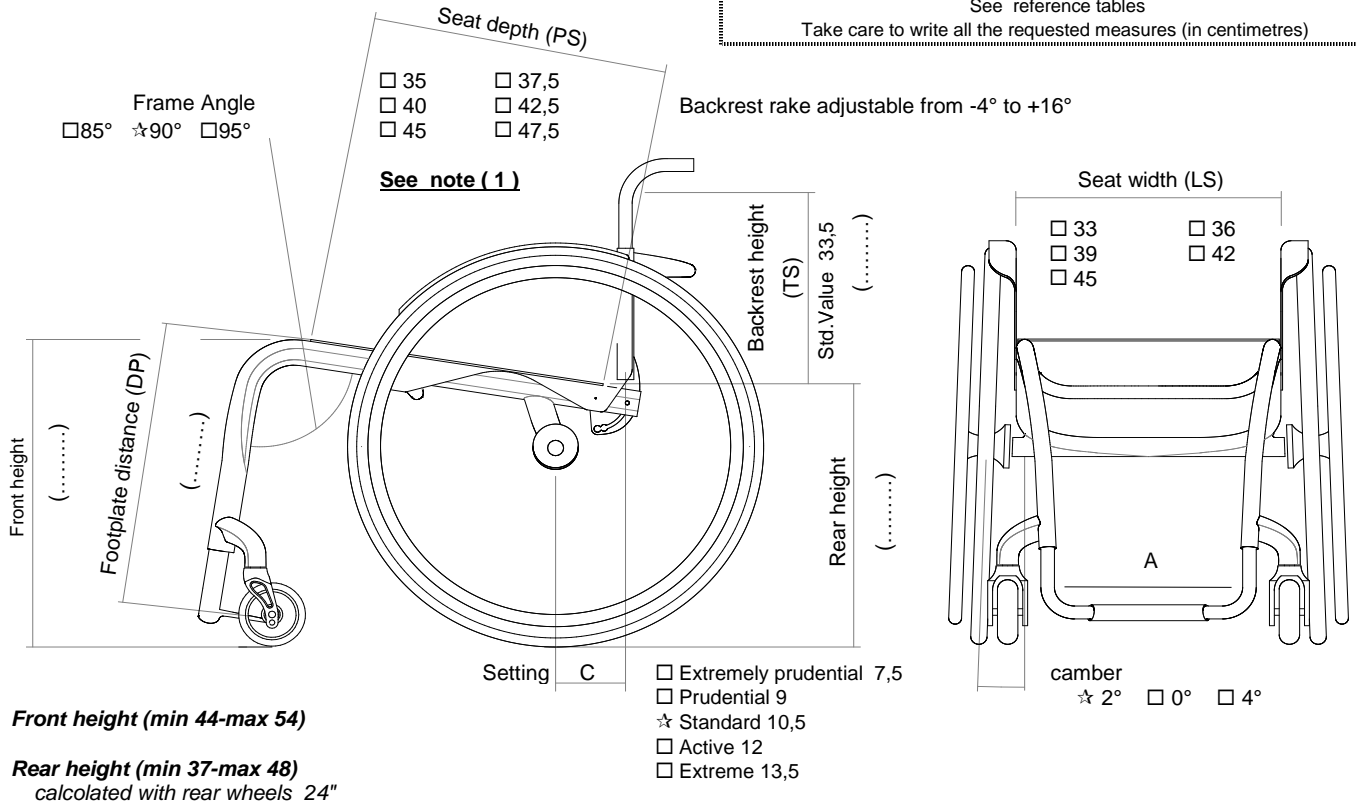

**ESSENCE**

- CARBON Essence  
Polished transparent paining
- OPAQUE Essence  
Opaque transparent painting 08925
- LIME Essence 08926
- RED Essence 08927
- BLUE Essence 08928
- ANTHRACITE + OPAQUE Essence 08929

**Fork colour**

- Opaque black
- Pearl white

**Footplate option**

Carbon fibre frame with integrated footplate, not adjustable  
(Lightest configuration)

Aluminium footplate adjustable distance +/- 1,5cm (rake and depth adjustable)  
Minimum footplate distance 35cm.

- Internal  2/3 Internal
- External  2/3 External

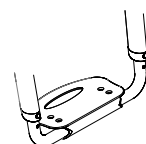

English  
Date ..... Order ..... User name ..... Address .....

**Seat**

☆ Seat cloth with pocket (under seat)

Seat with tension straps 08883

Carbon rigid seat 08336

Pocket (under seat) [25x11x4,5] 08281

**Backrest with rake adjustable from -4° to +16°**

☆ Backrest with double locking (upright and folded)

Backrest with upright locking system ONLY (no locking when folded)

Fixed back (non-folding back)

☆ Carbon fibre backrest (Lightest configuration)

Titanium backrest

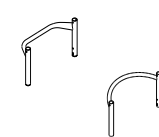

**AIR - Integrated posture backrest (not removable) - Lateral retaining 6,5cm.** 06815  
not available for seat width 48 - Std. Backrest upholstery not provided - Handle tube aluminium with short tubes

**Lateral retaining wing B=low**

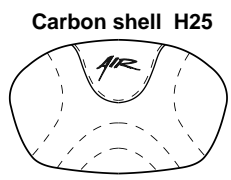

Backrest Height (TS) min 29 ..... max 41

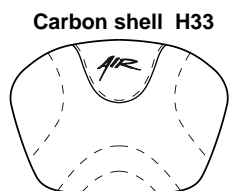

Backrest Height (TS) ..... (37 + 46)

**Lateral retaining wing A=high**

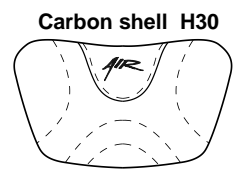

Backrest Height (TS) ..... (32 + 42,5)

**AIR Cover**

☆ Cover Standard - fabric insert: GREY, stitchings GREY

**Cover SPORT** 09195

- fabric insert: BLACK - Stitchings GREY
- fabric insert: BLACK - Stitchings LIME
- fabric insert: BLACK - Stitchings ORANGE
- fabric insert: BLACK - Stitchings RED
- fabric insert: BLACK - Stitchings BLUE
- fabric insert: BLACK - Stitchings BLACK
- fabric insert: BLACK - Stitchings FUCHSIA
- fabric insert: BLACK - Stitchings ANTHRACITE

**Cover ACTIVE** 09195

- fabric insert: RED - Stitchings BLACK
- fabric insert: LIME - Stitchings BLACK
- fabric insert: BLUE - Stitchings BLACK

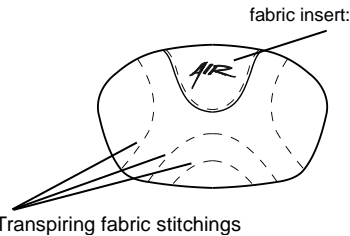

**Handle tube**

☆ Handle tube with short tubes

Handle tube SPORT Without push handles (Lightest configuration)

Folding handles aluminium 02958



**Casters**

☆ 3" Sport (Lightest configuration)

4" Soft

3" Active Soft (wide) (Aluminium alloy rim)

4" Active Sport (narrow) (Aluminium alloy rim)

4" Active Soft (wide) (Aluminium alloy rim)

5" Active Soft (wide) (Aluminium alloy rim)

**Rear wheels - See chart N°3**

☆ 24" ULTRA-LIGHT PROGEO KEY SPORT (Lightest configuration)

24" Ultra-light "Spinergy LX"

24" Ultra-light "Spinergy LXL"  Black hub and white blade spokes  Hub and blade spokes black

25" Ultra-light "Spinergy LX"

25" Ultra-light "Spinergy LXL"  Black hub and white blade spokes

26" Ultra-light "Spinergy LX"

24" Ultra-light "Spinergy Flex rim" 04353

Rehateam s.r.l. - Vicolo Negrilli, 4 - 31040 Castagnole di Paese (TV) - Tel. +39.0422.484657 / +39.0422.480387 - Fax +39.0422.484661 / +39.0422.484684  
P.IVA IT 03182520266 - C.C.I.A.A. TV n.225867 - Iscr. Trib. TV n.41690 Capitale Sociale I.V. Euro 100.000,00

Email: info@rehateamprogeo.com - web: http://www.rehateamprogeo.com

Date	Order	English User name	Address
------	-------	----------------------	---------





**Rear wheel tyre**

<input checked="" type="checkbox"/> High pressure tyre	(22"-24"-25"-26")	<b>(Lightest configuration)</b>	
<input type="checkbox"/> High pressure profile tyre	(24")		
<input type="checkbox"/> Marathon Plus	(24"-25")	with anti-puncture protection	01669
<input type="checkbox"/> Solid tyre Kik Mako - Colour Black	(24")		01041
<input type="checkbox"/> Solid tyre Kik Mako - Colour Grey	(24")		01751

**Handrim - Wheel distance**       3 cm       4 cm

<input checked="" type="checkbox"/> Aluminium	(22"-24"-25"-26")	<b>(Lightest configuration)</b>	
<input type="checkbox"/> Aluminium black SOFT-TOUCH	(24"-25")		09170
<input type="checkbox"/> Chromed Steel	(24"-25")		01684
<input type="checkbox"/> Titanium	(24"-25")		00016
<input type="checkbox"/> Ultra Grepp	(24"-25")		00017
<input type="checkbox"/> Max Grepp	(24"-25")		00834
<input type="checkbox"/> Ergo Para	(24")		00632
<input type="checkbox"/> SURGE LT	(24"-25")	Oval countour with a rubber insert	06427
<input type="checkbox"/> Quad (24")	(24")		00693
<input type="checkbox"/> Silicon cover for standard aluminium handrim		Available for measures (22"-24"-25"-26")	04050

**Wheel locks**

<input checked="" type="checkbox"/> Without brake		
<input type="checkbox"/> Bent lever push to lock		
<input type="checkbox"/> Straight lever Push to lock		
<input type="checkbox"/> Straight lever Pull to lock		
<input type="checkbox"/> Sport brake OUT-FRONT	<b>(Lightest configuration)</b>	
<input type="checkbox"/> Brake with extension lever push to lock		
<input type="checkbox"/> Brake with extension lever pull to lock		



**Mudguard**

<input checked="" type="checkbox"/> Carbon fibre mudguard				
<input type="checkbox"/> Carbon fibre Straight sideguard	<input checked="" type="checkbox"/> Aligned wheel	<input type="checkbox"/> Under wheel ..... cm	<input type="checkbox"/> Above wheel ..... cm	
<input type="checkbox"/> Removable carbon fibre mudguard				04109
<input type="checkbox"/> Removable Carbon fibre straight sideguard	<input checked="" type="checkbox"/> Aligned wheel	<input type="checkbox"/> Under wheel ..... cm	<input type="checkbox"/> Above wheel ..... cm	04109

**Armrests**

<input type="checkbox"/> Swing away armrests	<b>(Swing away, removable and height adjustable armrest)</b>		00694
	<input checked="" type="checkbox"/> Pad STANDARD		
	<input type="checkbox"/> Ergonomic pad (30x6 cm.)		04104

**Optional 1**

<input type="checkbox"/> Pad for front frame protectors			07058
<input type="checkbox"/> Transit wheels			03290
<input type="checkbox"/> Anti-tipper with rapid hookup	<b>(inside rotation to reduce the encumbrance)</b>		
	<input type="checkbox"/> Right		06821
	<input type="checkbox"/> Left		06822

Rehateam s.r.l. Viale Negrelli, 4 - 31040 Castagnole di Paese (TV) - Tel. +39.0422.484657 / +39.0422.480387 - Fax +39.0422.484661 / +39.0422.484664  
 P.IVA IT 03182520266 - C.C.I.A.A. TV n.225867 - Iscr. Trib. TV n.41690 Capitale Sociale I.V. Euro. 100.000,00

Email: info@rehateamprogeo.com - web: http://www.rehateamprogeo.com

Date ..... Order ..... English User name ..... Address .....

**Optional 2**



- Lumbar support (to insert in the backrest upholstery) 00013
- Tetraclip (Quick release axle for quadriplegic) 03947

**Additional Kit**

- 24" Off-road rear wheels (only with aluminium handrim) 03378

**PHYSIO - Posture backrest**

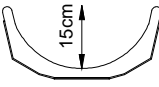
Std. Backrest upholstery not provided

- Aluminum shell Lateral retaining STANDARD 7,5cm
 
 Height  25  33  41 05308  
 Height  52 05309  
 Lateral retaining wing  A=high  B=low
- Aluminum shell Lateral retaining DEEP 15cm
 
 Height  25  33  41 05310  
**H 25 not available for seat width 39-42-45-48**  
 Height  52 05311  
 Lateral retaining wing  A=high  B=low
- Carbon shell Lateral retaining STANDARD 7,5cm
 
 Height  25  33  41 05312  
 Lateral retaining wing  A=high  B=low

**COVER**

☆ Cover with fabric-cover of backrest's rear side and high refraction fabric hems



- SWING AWAY - Lateral support  
Not available with Physio backrest with lateral retaining DEEP and in carbon backrest

Internal thoracic support to the backrest width, adjustable (0 ÷ -1,5cm)

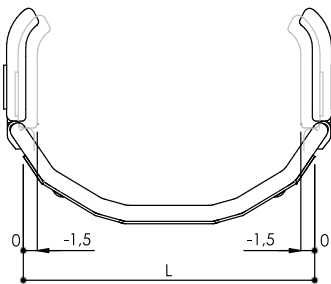

- Large (17,5x11,5)
  - Left 05646  Right 05647
  - Small (14x9,5)
    - Left 05642  Right 05643
- Additional Kit for internal thoracic support to the backrest width, adjustable (-8,5 ÷ -10cm)

Internal thoracic support to the backrest width, adjustable (-4 ÷ -5,5cm)

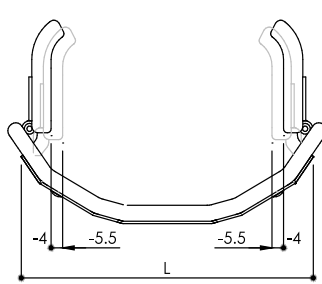

- Large (17,5x11,5)
  - Left 05646  Right 05647
  - Small (14x9,5)
    - Left 05642  Right 05643

Internal thoracic support to the backrest width, adjustable (-8,5 ÷ -10cm)

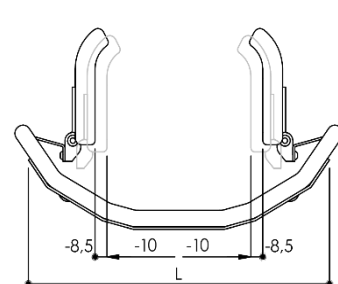

- Large (17,5x11,5)
  - Left 05646  Right 05647
  - Small (14x9,5)
    - Left 05642  Right 05643
- (with additional kit)

- Headrest adjustable - Double ball mounting system  
Not available for Physio backrest's height 25 and with carbon shell

- Large (34x14)
- Small (28x14)



05648

Rehateam s.r.l. - Vico Negrilli, 4 - 31040 Castagnole di Paese (TV) - Tel. +39.0422.484657 / +39.0422.480387 - Fax +39.0422.484661 / +39.0422.484684  
 P.IVA IT 03182520266 - C.C.I.A.A. TV n.225867 - Iscr. Trib. TV n.41690 Capitale Sociale I.V. Euro 100.000,00

Email: info@rehateamprogeo.com - web: http://www.rehateamprogeo.com

Date ..... Order ..... English User name ..... Address .....

## REFERENCE TABLES

**IMPORTANT NOTICE** Keep attention to all measures.  
**NOIR is a wheelchair without possibilities of adjustments after its manufacturing.**  
 (1) The real seat depth, from the front part of the seat cloth to the backrest tube will be 1,5 cm more than the declared one.

1	A Footplate width			
	DP	35÷39	40÷45	46÷50
LS				
33		21,5	21	20,5
36		24,5	24	23,5
39		27,5	27	26,5
42		30,5	30	29,5
45		33,5	33	32,5
48		36,5	36	35,5

2	Setting	C :
	Extremely prudential	7,5
	Prudential	9
	Standard	10,5
	Active	12
	Extreme	13,5

3	Maximum width
Camber	
0°	LS + 18
2°	LS + 21
4°	LS + 24

Maximum width calculated including 3 cm. distance between tyre and handrim

Rehateam s.r.l. - Vicolo Negrelli, 4 - 31040 Castagnole di Paese (TV) - Tel. +39.0422.484657 / +39.0422.480387 - Fax +39.0422.484661 / +39.0422.484684  
 P.IVA IT 03182520266 - C.C.I.A.A. TV n. 225867 - Iscr. Trib. TV n. 41690 Capitale Sociale I.V. Euro 100.000,00

Email: info@rehateamprogeo.com - web: http://www.rehateamprogeo.com